

EDKLN3LR-4
13550977



L-force Drives

Montageanleitung

Mounting Instructions

Instructions de montage

Instrucciones para el montaje

Istruzioni per il montaggio

EZAELN

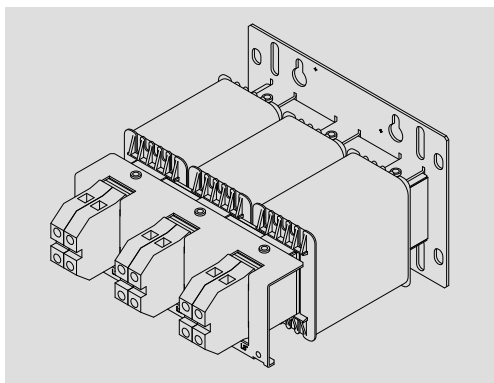

EZAELN3...

Netzdrossel

mains choke

self réseau

reactancia de red

induttanza di rete

Lenze



Lesen Sie zuerst diese Anleitung und die Dokumentation zum Grundgerät, bevor Sie mit den Arbeiten beginnen!

Beachten Sie die enthaltenen Sicherheitshinweise.



Gefahr!

Gefährliche elektrische Spannung

Alle Leistungsanschlüsse führen auch nach Netz-Ausschalten für längere Zeit elektrische Spannung, z. B. aus Kondensatoren.

Mögliche Folgen:

- ▶ Tod oder schwere Verletzungen beim Berühren der Leistungsanschlüsse.

Schutzmaßnahmen:

- ▶ Vor Arbeiten an den Leistungsanschlüssen Netz abschalten und die Entladung abwarten.
- ▶ Vor den Arbeiten prüfen, ob alle Leistungsanschlüsse spannungsfrei sind.

Technische Daten			
Schutzart	EN 60529	Siehe Typenschild	
Isolationsfestigkeit	EN 61558-2-20	Überspannungskategorie III Reduzierung ab 2000 m: Überspannungskategorie II	
Isolierstoffklasse		Siehe Typenschild Bei Dauerbetrieb mit Bemessungsdaten werden hohe Oberflächentemperaturen > 90 °C erreicht!	
Temperatur			
Lagerung		-25 ... +60 °C	
Transport		-25 ... +70 °C	
Betrieb		-10 ... +55 °C (Temperatur im Schaltschrank) Stromreduzierung von +40 ... +55 °C: 2.5 %/°C	
Verschmutzung	EN 61800-5-1	Verschmutzungsgrad 2	
Rüttelfestigkeit	EN50178; IEC61800-5-1; Germanischer Lloyd, allgemeine Bedingungen	Beschleunigungsfest bis 1 g	
Montageort, Einbaulage	Im Schaltschrank, empfohlen: hängend mit horizontaler Ausrichtung, ☐7 (bei größeren Massen auch stehend möglich)		
Bemessungsdaten, Konformität/Approb.	Siehe Typenschild Verlustleistung siehe Tabelle, ☐6		
Konformität und Approbation			
CE	2014/35/EU	Niederspannungsrichtlinie	
EAC	TP TC 004/2011 (TR ZU 004/2011)	Über die Sicherheit von Niederspannungsaus- rüstung	Eurasische Konformität TR ZU: Technische Regulie- rung der Zollunion
Approbation			
cUR _{U5}	UL 506 CSA 22.2	Transformers, General Purpose - Component File No. E103521	



Please read these instructions and the documentation of the standard device before you start working!
Observe the safety instructions given therein!



Danger!

Hazardous electrical voltage

Even after mains disconnection, all power terminals remain live for a longer while, e.g. due to capacitors.

Possible consequences:

- ▶ Death or severe injuries when touching the power terminals.

Protective measures:

- ▶ Switch off the power supply and wait until the power terminals are discharged before working on them.
- ▶ Make sure that all power terminals are deenergised before working on them.

Technical data			
Enclosure	EN 60529	see name plate	
Insulation resistance	EN 61558-2-20	Overvoltage category III > 2000 m: Overvoltage category II	
Class of insulation		See nameplate In continuous operation with rated data, high surface temperatures > 90 °C are reached!	
Temperature			
Storage		-25 ... +60 °C	
Transport		-25 ... +70 °C	
Operation		-10 ... +55 °C (Temperature in the control cabinet) Current derating from +40 ... +55 °C: 2.5 %/°C	
Pollution	EN 61800-5-1	Pollution degree 2	
Vibration resistance	EN 50178; IEC 61800-5-1; Germanischer Lloyd, general conditions	Acceleration-resistant up to 1 g	
Mounting location, mounting position	In the control cabinet, recommended: Suspended with horizontal alignment, □7 (with greater masses, standing is also an option)		
Rated data, conformity/approval	See nameplate For power loss see table, □6		

Conformity and approval			
CE	2014/35/EU	Low-Voltage Directive	
EAC	TP TC 004/2011 (TP ZU 004/2011)	Regarding the safety of low-voltage equipment	Eurasian conformity TR ZU: Technical regulation of the tariff union
Approval			
cUR _{US}	UL 506 CSA 22.2	Transformers, General Purpose - Component File No. E103521	

$U_N = 600 \text{ V}$

	I_N [A]	L [mH]	P_V [W]
EZAELN3002B203	1.5	19.6	3.8
EZAELN3002B153	2	14.7	5.8
EZAELN3004B742	4	7.35	11.5
EZAELN3006B492	6	4.9	17.3
EZAELN3008B372	8	3.68	23.1
EZAELN3010B292	10	2.94	28.9
EZAELN3016B182	16	1.84	46.1
EZAELN3020B152	20	1.47	57.6
EZAELN3025B122	25	1.18	72.0
EZAELN3030B981	30	0.98	86.4
EZAELN3035B841	35	0.84	101
EZAELN3040B741	40	0.74	116
EZAELN3045B651	45	0.65	130
EZAELN3050B591	50	0.59	144
EZAELN3063B471	63	0.47	181
EZAELN3080B371	80	0.37	230
EZAELN3090B331	90	0.33	273
EZAELN3100B301	100	0.30	303
EZAELN3125B241	125	0.24	378
EZAELN3160B191	160	0.19	500
EZAELN3180B171	180	0.17	570
EZAELN3200B151	200	0.15	605
EZAELN3250B121	250	0.12	758

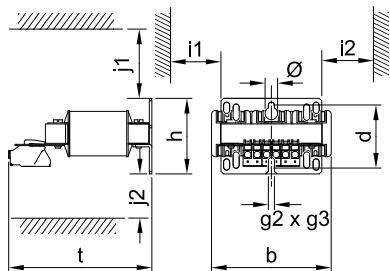

EZAELN301

	b	h	t	d	$g2 \times g3$ \varnothing	i1, i2	j1, j2	
	[mm]							[kg]
EZAELN3002B203	77	56	100	42.5	4.8 x 9 9.5	30	50	0.52
EZAELN3002B153	77	56	100	42.5				0.53
EZAELN3004B742	95	60	115	49.3				1.31
EZAELN3006B492	95	69	120	58.5				1.45

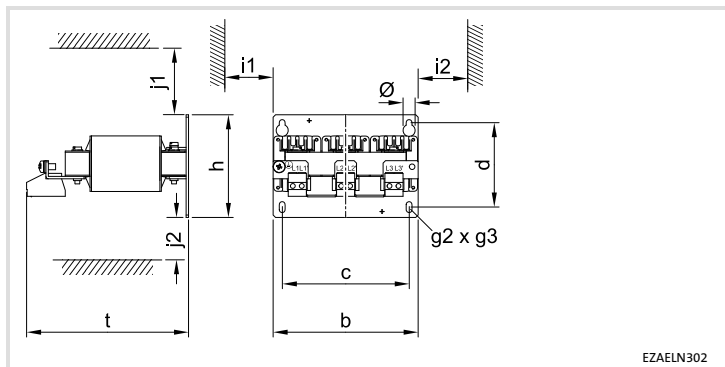

EZAELN302

	b	h	t	c	d	g2 x g3 Ø	i1, i2	j1, j2	⚡ [kg]
	[mm]								
EZAELN3008B372	120	85	140	105	70	4.8 x 9 9.5	30	50	1.90
EZAELN3010B292	120	85	140	105	70				2.00
EZAELN3016B182	120	95	140	105	80	5.8 x 11 10.5			2.70
EZAELN3020B152	155	95	165	135	80				3.80

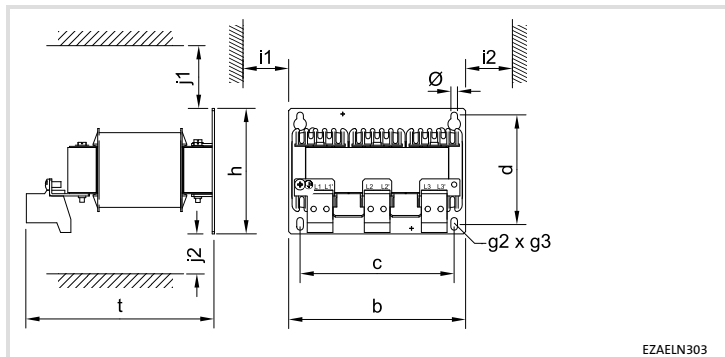

EZAELN303

	b	h	t	c	d	$g2 \times g3$ \emptyset	$i1, i2$	$j1, j2$	 [kg]
	[mm]								
EZAELN3025B122	155	110	170	135	95	5.8 x 11 10.5	30	50	5.80
EZAELN3030B981	155	110	170	135	95				5.85
EZAELN3035B841	155	110	170	135	95				5.95
EZAELN3040B741	185	102	200	170	57	8 x 12 13			6.80
EZAELN3045B651	185	112	200	170	67				8.25

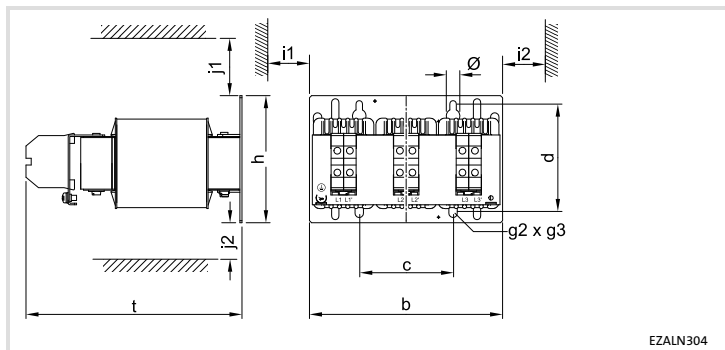

EZALN304

	b	h	t	c	d	$g2 \times g3$ \emptyset	i1, i2	j1, j2	
	[mm]								[kg]
EZAELN3050B591	185	112	210	90	93	8 x12 13	30	75	8.35
EZAELN3063B471	185	122	210	90	103				9.65
EZAELN3080B371	210	125	240	105	106				12.5

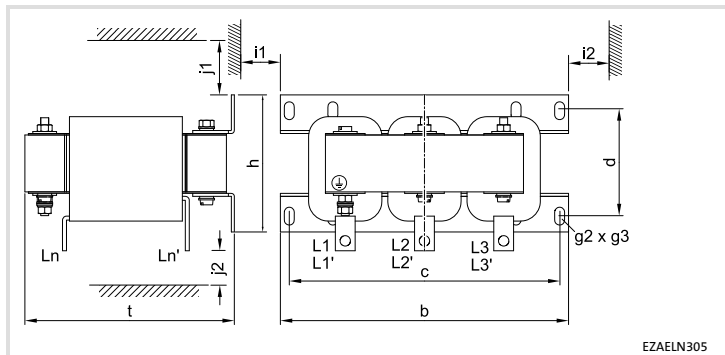



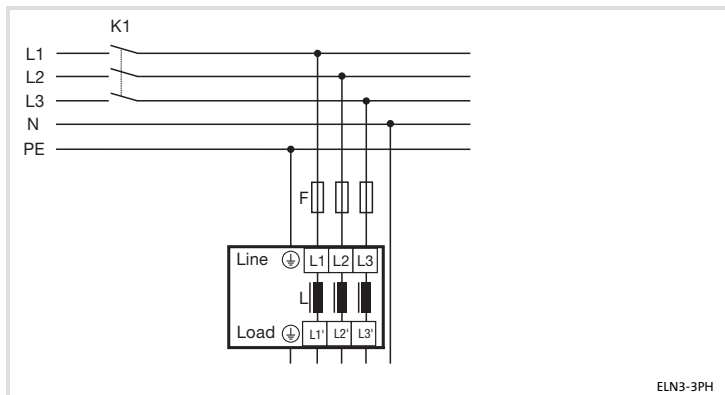

EZAELN305

	b	h	t	c	d	g2 x g3	i1,i2	j1, j2	
	[mm]								[kg]
EZAELN3090B331	267	115	205	249	78.5	7 x 13	30	100	11.5
EZAELN3100B301	267	139	205	249	102.5				16.5
EZAELN3125B241	291	139	215	273	106.5	10 x 18			17.5
EZAELN3160B191	291	149	215	273	116.5				22.5
EZAELN3180B171	316	164	235	292	123.5	10 x 16			26.0
EZAELN3200B151	352	144	265	328	103.5				25.0
EZAELN3250B121	352	158	265	328	115.0		31.4		



ELN3-3PH

	L1, L2, L3, L1', L2', L3'		⊕/PE	
				
	max. [mm ²] [AWG]	[Nm] [lb-in]	max. [mm ²] [AWG]	[Nm] [lb-in]
EZAELN3002B203 EZAELN3002B153	4 10	0.5 ... 1.0 4.4 ... 8.9	(6.3x0.8) 6 10	- -
EZAELN3004B742 EZAELN3006B492	4 10	0.5 ... 1.0 4.4 ... 8.9	(6.3x0.8) 6 10	- -
EZAELN3008B372 ... EZAELN3020B152	4 10	0.5 ... 1.0 4.4 ... 8.9	(M5)	3.0 26.6
EZAELN3025B122 ... EZAELN3045B651	10 6	1.2 ... 2.0 10.6 ... 17.7	(M5)	3.0 26.6
EZAELN3050B591 EZAELN3063B471	16 4	2.0 ... 4.0 17.7 ... 35.4	(M5)	3.0 26.6
EZAELN3080B371	35 2	2.5 ... 5.0 22.1 ... 44.2	(M8)	18 159
EZAELN3090B331 EZAELN3100B301	(M8)	18 159	(M8)	18 159
EZAELN3125B241 EZAELN3160B191	(M10)	37 327	(M8)	18 159
EZAELN3180B171 EZAELN3200B151	(M12)	64 566	(M8)	18 159
EZAELN3250B121	(M12)	64 566	(M8)	18 159

© 03/2018



Lenze Automation GmbH
Postfach 10 13 52, 31763 Hameln
Hans-Lenze-Str. 1, 31855 Aerzen
GERMANY
HR Hannover B 205381



+49 5154 82-0



+49 5154 82-2800



lenze@lenze.com



www.lenze.com

Service Lenze Service GmbH
Breslauer Straße 3, 32699 Extertal

GERMANY



008000 2446877 (24 h helpline)



+49 5154 82-1112



service@lenze.com

EDKLN3LR-4 ■ 13550977 ■ DE/EN/FR/ES/IT ■ 5.0 ■ TD15

10 9 8 7 6 5 4 3 2 1