



## TERMS



- 1) Adjusted potentiometer value is seen in run mode  
Parameter name, value or its unit in programming mode.
- 2) Increment key during run mode.  
Increment or parameter selection key during programming mode.
- 3) Decrement key during run mode.  
Decrement or parameter selection key during programming mode.
- 4) Used for selecting run or programming modes and for adjusting parameters.

( 1 ) Digital display	12,5 mm 4 digits 7 segment red LED display
( 2 ),( 3 ),( 4 ) Keypad	Micro switch

## DIMENSIONS

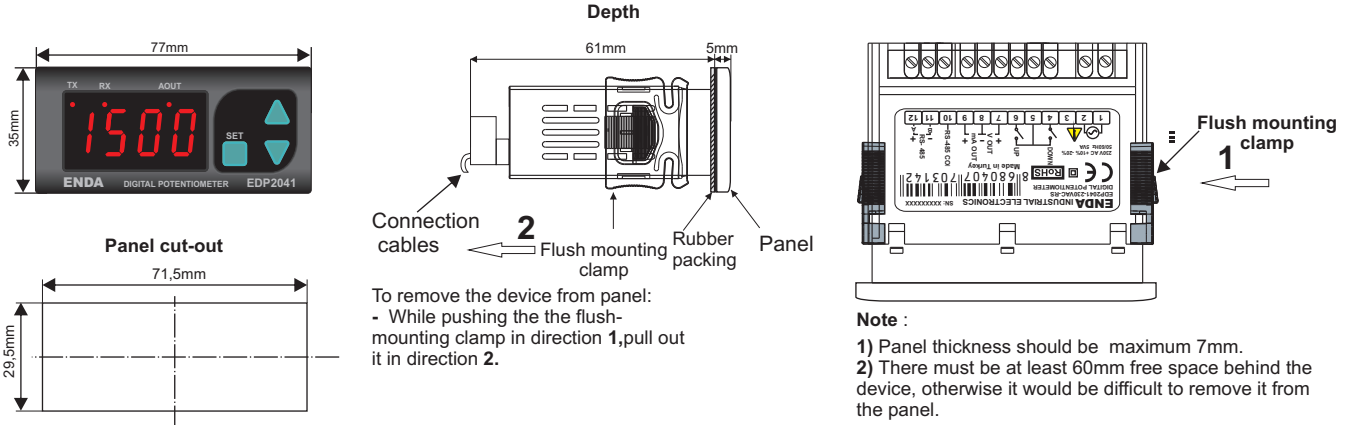

## CONNECTION DIAGRAM



ENDA EDP2041 is intended for installation in control panels. Make sure that the device is used only for intended purpose. The electrical connections must be carried out by a qualified staff and must be according to the relevant locally applicable regulations. During an installation, all of the cables that are connected to the device must be free of electrical power. The device must be protected against inadmissible humidity, vibrations, severe soiling. Make sure that the operation temperature is not exceeded. The cables should not be close to the power cables or components.

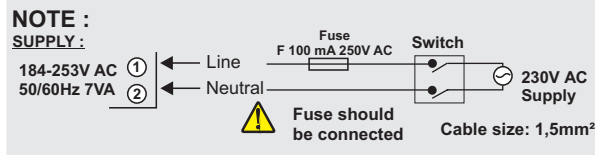
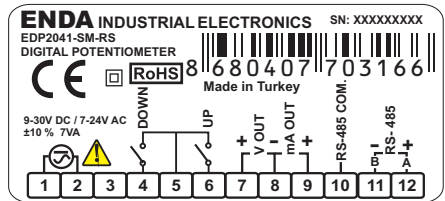
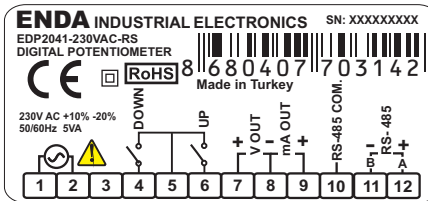
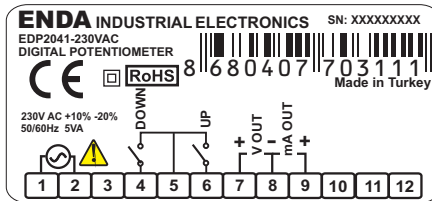

Equipment is protected throughout by DOUBLE INSULATION.

RoHS Compliant

Holding screw 0.4-0.5Nm

**Note :**  
1) Mains supply cords shall meet the requirements of IEC 60227 or IEC 60245.  
2) In accordance with the safety regulations, the power supply switch shall bring the identification of the relevant instrument and it should be easily accessible by the operator.

## CONNECTION DIAGRAM FOR SYNCHRONOUS RUNNING

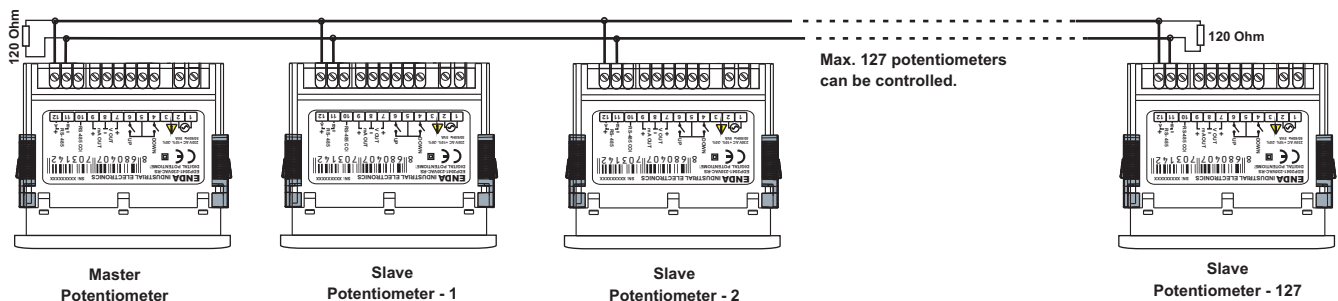

### NOTE :

- *dRdr* parameter should be selected *C.Pot* in master potentiometer. In this case *dRdr* parameter of other potentiometers aren't used. But be sure that *C.Pot* isn't selected in slave potentiometers to prevent confusion. Settings of slave potentiometers change proportional to setting of master potentiometer. For example; When Max. output of master potentiometer is changed from 10V to 5V, max. output of slave potentiometers decrease half of previous value proportional to this. If previous output of slave potentiometer is 6V, it decreases 3V. *PonC* parameter of slave potentiometer should be selected *oFF* in order to understand master potentiometer when slave is energized.
- Computer should be used to change only a few potentiometers. In this case, there is not master potentiometer. Output of the required potentiometer is changed according to *dRdr* parameter.
- Baud rate of potentiometers must be same in both conditions. 120 Ohm termination resistor should be used at the ends and beginning of transmission line.

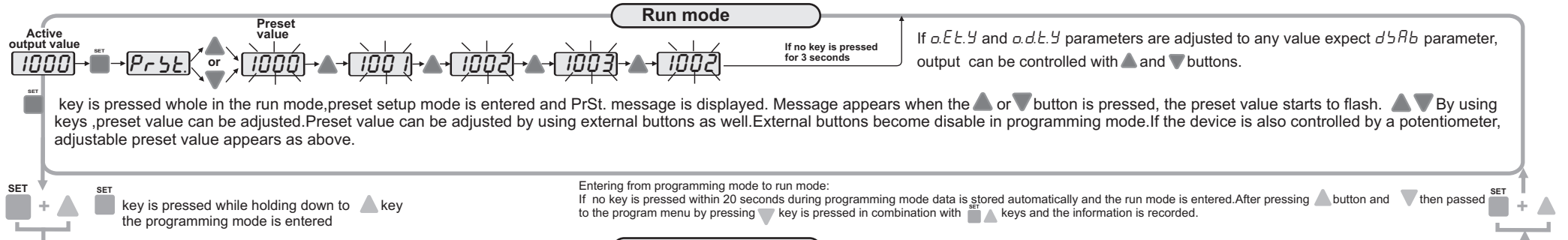

**Default Parameters**

- dPnt.** = Display decimal point parameter. Decimal point can be adjusted between 1. and 3. digits. See NOTE 1 for programming.
  - L5cl.** = Lower value of the scale. Adjustable between -1999 and (H5cl.-10). Scale the lower value of the output, based on *oEtYP* parameter selection, it is 0V, 0mA or 4mA. See NOTE 1 for programming.
  - H5cl.** = Upper value of the scale. Adjustable between (L5cl.+10) and 9999. Scale the upper value of the output based on *oEtYP* parameter selection; it is 10V or 20 mA. H5cl. and L5cl. difference can not be greater than 9999. See NOTE 1 for programming.
  - LoLi.** = The lower limit of the preset value. Adjustable between L5cl. and (H5cl.-10). See NOTE 1 for programming.
  - HiLi.** = The upper limit of the preset value. Adjustable between (LoLi.+10) and H5cl. See NOTE 1 for programming.
  - dAdr.** = Device address for ModBus. Adjustable between 1-247 or selectable *cPot.*. When *cPot.* is selected, the device will be master potentiometer and slave potentiometers can be adjusted dependent on it. See NOTE 1 for programming. ⚠ This parameter is active device with RS485 communication option.
  - bAud.** = Baud rate for the RS485 connection. Adjustable: off, 2400, 4800, 9600, 19200 and 38400. ⚠ This parameter is active device with RS485 communication option.
- Return to the menu.** While the parameter names appear, ▲ and ▼ keys are pressed together, the program will return to the menu display.

**NOTE 1**

**Parameter adjustment method**

For adjusting a selected parameter first press and hold SET key. Then, by using ▲ ▼ keys, adjustment can be made.

If increment key ▲ is pressed and held 0.6 seconds, the value of the selected parameter changes rapidly. If waited enough, the value increases 100 at each step. After 1 second following the release of the key, initial condition is returned. The same procedure is valid for the decrement key.

**Default parameters**

- PonC.** = Selection of the output parameter behavior. ⚠ *oFF* = When first energized, output is the voltage or current that lower limit value is indicated. Attention: If this parameter is selected, the set value that was adjusted before is seen when set button is pressed at first. In addition, if increasing or decreasing that value is wanted before the set value is equalized to lower limit value and then adjustment can be done. *oN* = When first energized, output is the voltage or current that the set value is indicated.
- aEtY.** = Adjusted type of the output to preset value with ▲ button. *dsAb* = Output can not be adjusted to preset value with ▲ button. *Enb.* = Output can be adjusted to preset value with ▲ button. *son* = Output is increased to voltage that set value is displayed with ▲ button during *rEt.* See NOTE 1 for programming.
- odtY.** = Adjusted type of the output to lower limit value with ▼ button. *dsAb* = Output can not be adjusted to lower limit value with ▼ button. *Enb.* = Output can be adjusted to lower limit value with ▼ button. *soFF* = Output is increased to voltage that lower limit value is displayed with ▼ button during *dt.* See NOTE 1 for programming.
- EEtY.** = Returning method of the output to preset value with the external "Up" input. *oEtY* is set like the output parameter.
- EdtY.** = Returning method of the output to preset value with the external "Down" input. *odtY* is set like the output parameter.
- rEt.** = Increasing time for output. Adjustable between 1-250 seconds. Output is increased slowly to the lower limit value during adjusted time.
- dt.** = Decreasing time for output value. Adjustable between 1-250 seconds. Output is decreased slowly to the lower limit value during adjusted time. See NOTE 1 for programming.
- PirEt.** = Increasing and decreasing speed of preset value. It is adjusted *dsAb.* 1, 10, 100 ve 1000 values. *dsAb* is selected, the preset value can not be changed. Selected according to the value increase or decrease the preset buttons for fast switching mode, the preset value speed is increased or decreased "one by one", 10 at each step, 100 at each step, 1000 at each step.
- oEtYP.** = Output type selection parameter. 0-10 = 0-10V output usable. 4-20 = 4-20mA output usable. 0-20 = 0-20mA output usable. See NOTE 1 for programming.

**Default parameters**

- Scod.** = Access code for safety menu. This parameter should be 2041. Security code is 0; ▼ key is pressed continuously for 5 seconds, *dEFP* message is displayed and return to menu.
- UC5c.** = *Ucnf.* menu protection level parameter. *nonE* = No menu is seen. *PYE5* = Modification feasible. *P.no* = Only traceable.
- oC5c.** = *aCnf.* menu protection level parameter. *nonE* = No menu is seen. *PYE5* = Modification feasible. *P.no* = Only traceable. *P.no* = Menu visible.

**OUTPUT DIAGRAM**

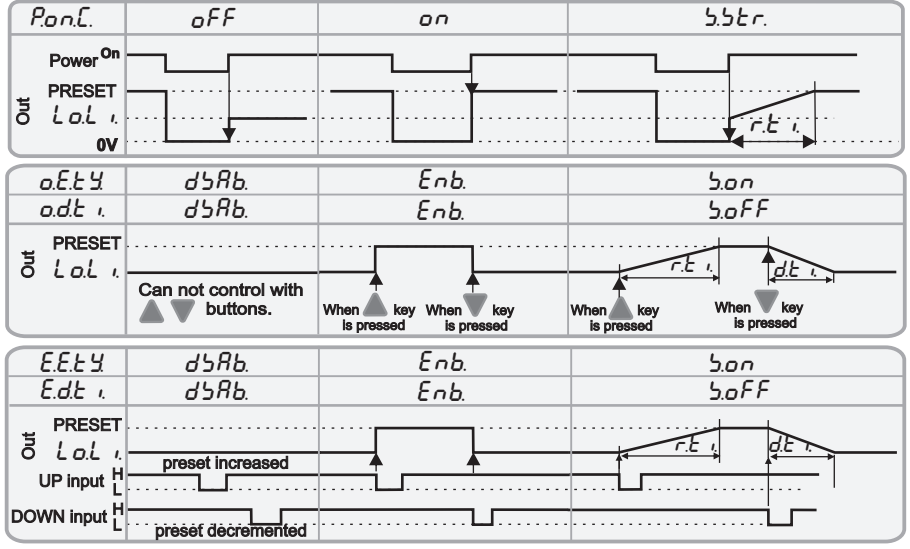

# ENDA EDP2041 DIGITAL POTENTIOMETER

## MODBUS PROTOCOL ADDRESS MAP

### 1.1 Memory map for Holding Registers

Parameter Number	Holding Register addresses Decimal (Hex)	Data Type	Data Content	Parameter Name	Read/Write Permission	Default Parameters
H0	0000d (0000h)	Word	Percentage of the external control.Adjustable between %0.00 and %100.0		Readable / Writable	10000
H1	0001d (0001h)	Word	Preset value	<i>PrSt.</i>	Readable / Writable	1000
H2	0002d (0002h)	Word	Decimal point	<i>dPnt.</i>	Readable / Writable	0
H3	0003d (0003h)	Word	The lower value of the scale	<i>LsCl.</i>	Readable / Writable	0
H4	0004d (0004h)	Word	The upper value of the scale	<i>UsCl.</i>	Readable / Writable	9999
H5	0005d (0005h)	Word	The lower limit of the preset value	<i>LoL i.</i>	Readable / Writable	0
H6	0006d (0006h)	Word	The upper limit of the preset value	<i>HiL i.</i>	Readable / Writable	2000
H7	0007d (0007h)	Word	Device address for Rs485 network connection (Adjustable between 1-247.) If set to "0", the control potentiometer mode is entered.	<i>dAdr.</i>	Readable / Writable	1
H8	0008d (0008h)	Word	Baud rate selection ( 0= None;1=2400bps ; 2=4800bps ; 3=9600bps ; 4=19200bps; 5=38400bps)	<i>bAud.</i>	Readable / Writable	3
H9	0009d (0009h)	Word	The first opening the control parameter 0= oFF, 1= on, 2 = 55Er	<i>PonC.</i>	Readable / Writable	0
H10	0010d (000Ah)	Word	Output upper arrow button to fetch the value of the preset selection 0= d5Rb, 1= Enb, 2 = 5on	<i>oEtY.</i>	Readable / Writable	0
H11	0011d (000Bh)	Word	Output lower arrow button to fetch the value of the lower limit selection 0= d5Rb, 1= Enb, 2 = 5oFF.	<i>oDtY.</i>	Readable / Writable	0
H12	0012d (000Ch)	Word	Time to increase the output voltage	<i>rEt i.</i>	Readable / Writable	30
H13	0013d (000Dh)	Word	Time to decrease the output voltage	<i>dEt i.</i>	Readable / Writable	30
H14	0014d (000Eh)	Word	Preset the value of the increment and decrement rate or cancel the setting 0 = cancel, 1=1,2=10,3=100,4=1000.	<i>P idt.</i>	Readable / Writable	1
H15	0015d (000Fh)	Word	Output type selection parameter 0 = 0-10V output, 1 = 4-20mA output, 2 = 0-20mA output	<i>oEtYP.</i>	Readable / Writable	0
H16	0016d (0010h)	Word	User security parameter configuration menu (0 = Menu invisible, 1= Menu programmable, 2 or 3 = Menu only traceable).	<i>U.C.S.C.</i>	Readable / Writable	1
H17	0017d (0011h)	Word	Output security parameter configuration menu (0 = Menu invisible, 1= Menu programmable, 2 or 3 = Menu only traceable).	<i>o.C.S.C.</i>	Readable / Writable	1
H18	0018d (0012h)	Word	Function control parameter (23040d (5A00h) value is entered,any function executed. (23041d (5A01h) value is entered,the default values will be restored.		Readable / Writable	0
H19	0019d (0010h)	Word	Returning method of the output to preset value with the external "Up" input. 0 = d5Rb, 1 = Enb, 2 = 5on	<i>E.EtY.</i>	Readable / Writable	0
H20	0020d (0011h)	Word	Returning method of the output to preset value with the external "Down" input. 0 = d5Rb, 1 = Enb, 2 = 5oFF.	<i>E.dEtY.</i>	Readable / Writable	0

### 1.2 Memory map for Coils

Parameter Number	Input Register addresses Decimal (Hex)	Data Type	Data Content	Parameter Name	Read/Write Permission	Default Parameters
I0	0000d (0000h)	Word	Instant set value	■■■	Only readable	■■■
I1	0001d (0001h)	Word	% of value the analog output (%0.00-%100.00 sensitivity)	■■■	Only readable	■■■

### 1.3 Memory map for Discrete Input

Parameter Number	Discrete input addresses	Data Type	Data Content	Parameter Name	Read/Write Permission	Default Parameters
D0	(0000)h	Bit	State of the external down button (0 = OFF ,1 = ON)	■■■	Only readable	■■■
D1	(0001)h	Bit	State of the external up button (0 = OFF ,1 = ON)	■■■	Only readable	■■■

## 2. MODBUS ERROR MESSAGES

Modbus protocol has two types error, communication error and operating error. Reason of the communication error is data corruption in transmission. Parity and CRC control should be done to prevent communication error. Receiver side checks parity and CRC of the data. If they are wrong, the message will be ignored. If format of the data is true but function doesn't perform for any reason, operating error occurs. Slave realizes error and sends error message. Most significant bit of function is changed '1' to indicate error in error message by slave. Error code is sent in data section. Master realizes error type via this message.

### ModBus Error Codes

Error Code	Name	Meaning
{01}	ILLEGAL FUNCTION	The function code received in the query is not an allowable action for the slave. If a Poll Program Complete command was issued, this code indicates that no program function preceded it.
{02}	ILLEGAL DATA ADDRESS	The data address received in the query is not an allowable address for the slave.
{03}	ILLEGAL DATA VALUE	A value contained in the query data field is not an allowable value for the slave.

#### Message example;

Structure of command message (Byte Format)

Device Address	(0A)h
Function Code	(01)h
Beginning address of coils.	MSB (04)h
	LSB (A1)h
Number of coils (N)	MSB (00)h
	LSB (01)h
CRC DATA	LSB (AC)h
	MSB (63)h

Structure of response message (Byte Format)

Device Address	(0A)h
Function Code	(81)h
Error Code	(02)h
CRC DATA	LSB (B0)h
	MSB (53)h

As you see in command message, coil information of (4A1)h = 1185 is required but there isn't any coil with 1185 address. Therefore error code with number (02) (Illegal Data Address) sends.