

EDBZAEBK000X
13282624

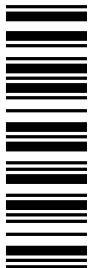

L-force Drives

Betriebsanleitung

Operating Instructions

Instructions de mise en service

Instrucciones para el servicio

Istruzioni operative

X400

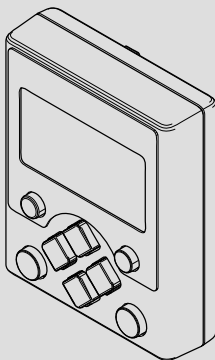

EZAEBK100x

Keypad

Keypad

Clavier de commande

Keypad

Tastiera

Lenze



Lesen Sie zuerst diese Anleitung und die Dokumentation zum Grundgerät, bevor Sie mit den Arbeiten beginnen!
Beachten Sie die enthaltenen Sicherheitshinweise.



Please read these instructions and the documentation of the standard device before you start working!
Observe the safety instructions given therein!



Lire le présent fascicule et la documentation relative à l'appareil de base avant toute manipulation de l'équipement !
Respecter les consignes de sécurité fournies.



Lea estas instrucciones y la documentación del equipo básico antes de empezar a trabajar.
Observe las instrucciones de seguridad indicadas.



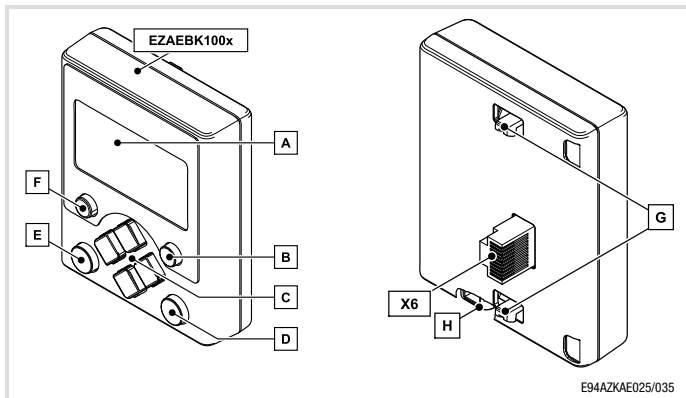

Prima di iniziare qualsiasi intervento, leggere le presenti istruzioni e la documentazione relativa al dispositivo di base.
Osservare le note di sicurezza.



E94AZKAE025/035

Elemente auf der Vorderseite

Pos.	Beschreibung
A	LCD-Anzeige
B	Rechte Funktionstaste
C	Navigationstasten 
D	Taste 
E	Taste 
F	Linke Funktionstaste

Elemente auf der Rückseite

Pos.	Beschreibung
G	Verriegelungshaken
H	Entriegelungsknopf
X6	Steckverbinder RJ69, Anschluss an Diagnoseschnittstelle (X6) am Grundgerät

Montage

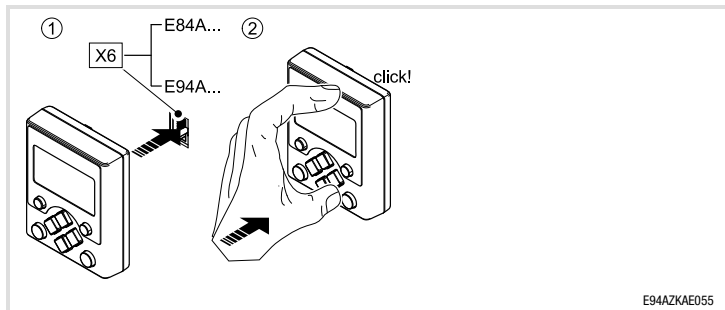

Demontage

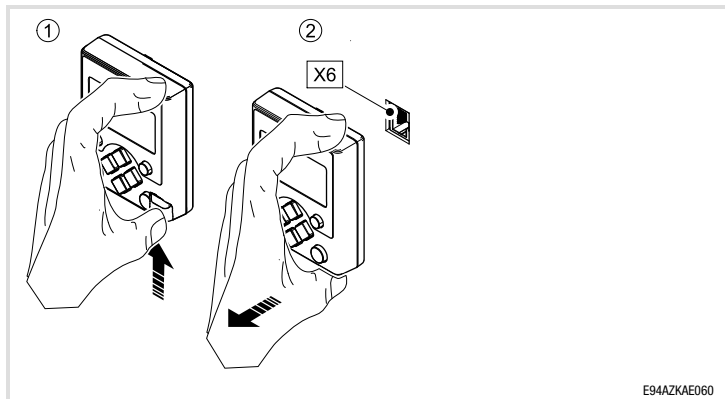

Gültigkeit

Diese Anleitung ist gültig für

► Keypad, Typ EZAEBK100x ab der Version HW: VA, SW: 02.00

Identifikation

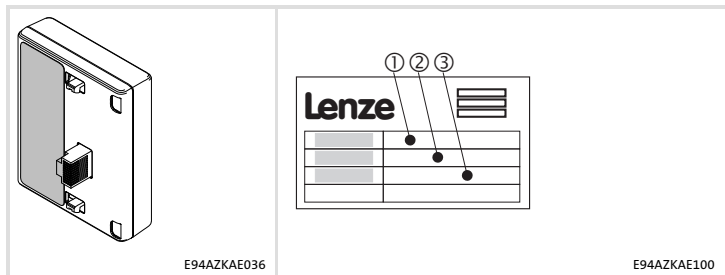

	①				②	③	
	EZ	AE	B	K	100x	xx	xx
Produktreihe: Zubehör							
Ausführung AE = Anzeige-Einheit							
Gerätegeneration							
Modultyp: Keypad							
Hardwarestand							
Softwarestand							

Einsetzbarkeit

Die Verwendung dieses Moduls ist zulässig mit Grundgeräten ab der Typenschildbezeichnung:

Produktreihe	Type	HW Ver.	SW Ver.
Servo Drives 9400	E94AxxExxxx	VB	01.10
Inverter Drives 8400	E84AxxxExxxxxxxxxx	VA	00.07



Tipp!

Dokumentationen und Software-Updates zu weiteren Lenze Produkten finden Sie im Internet im Bereich "Services & Downloads" unter

<http://www.Lenze.com>

1	Sicherheitshinweise	9
	Definition der verwendeten Hinweise	9
	Allgemeine Sicherheitshinweise	10
2	Technische Daten	11
3	Inbetriebnahme	12
4	Bedienung	13
	Anzeige-Elemente und Funktionstasten	13
	Menüstruktur	16
5	Konfiguration	17

Definition der verwendeten Hinweise

Um auf Gefahren und wichtige Informationen hinzuweisen, werden in dieser Dokumentation folgende Piktogramme und Signalwörter verwendet:

Sicherheitshinweise

Aufbau der Sicherheitshinweise:



Gefahr!

(kennzeichnet die Art und die Schwere der Gefahr)

Hinweistext



(beschreibt die Gefahr und gibt Hinweise, wie sie vermieden werden kann)

Piktogramm und Signalwort	Bedeutung
Gefahr!	Gefahr von Personenschäden durch gefährliche elektrische Spannung Hinweis auf eine unmittelbar drohende Gefahr, die den Tod oder schwere Verletzungen zur Folge haben kann, wenn nicht die entsprechenden Maßnahmen getroffen werden.
Gefahr!	Gefahr von Personenschäden durch eine allgemeine Gefahrenquelle Hinweis auf eine unmittelbar drohende Gefahr, die den Tod oder schwere Verletzungen zur Folge haben kann, wenn nicht die entsprechenden Maßnahmen getroffen werden.
Stop!	Gefahr von Sachschäden Hinweis auf eine mögliche Gefahr, die Sachschäden zur Folge haben kann, wenn nicht die entsprechenden Maßnahmen getroffen werden.

1 Sicherheitshinweise

Allgemeine Sicherheitshinweise

Anwendungshinweise

Piktogramm und Signalwort	Bedeutung
 Hinweis!	Wichtiger Hinweis für die störungsfreie Funktion
 Tipp!	Nützlicher Tipp für die einfache Handhabung
	Verweis auf andere Dokumentation

Allgemeine Sicherheitshinweise



Gefahr!

Unsachgemäßer Umgang mit dem Modul und dem Grundgerät kann schwere Personenschäden und Sachschäden verursachen.

Beachten Sie die in den Anleitungen zum Grundgerät enthaltenen Sicherheitshinweise und Restgefahren.

Bereich	Werte
Schutzart	IP20
Umgebungstemperatur	im Betrieb: -10 °C ... +55 °C Transport: -25 °C ... +70 °C Lagerung: -25 °C ... +55 °C
Klimatische Bedingungen	Klasse 3K3 nach EN 50178 (ohne Betauung, mittlere relative Feuchte 85 %)
Verschmutzungsgrad	EN 61800-5-1, Verschmutzungsgrad 2

3 Inbetriebnahme

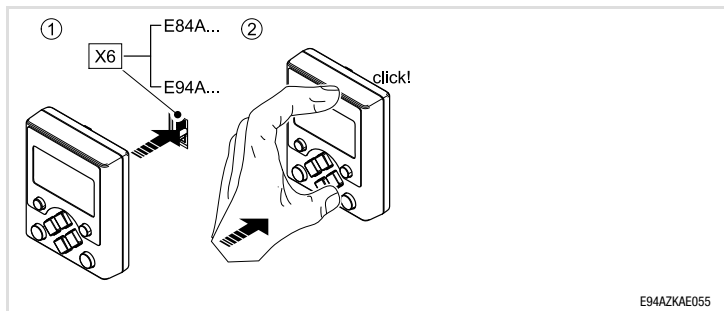

Inbetriebnahme-Schritte

Inbetriebnahme-Schritt	Bemerkung
1. Keypad auf der Frontseite des Grundgerätes an der Diagnoseschnittstelle X6 anschließen.	Sie können das Keypad auch während des Betriebs anschließen und wieder entfernen.
2. Wenn das Keypad mit Spannung versorgt wird, führt es einen kurzen Selbsttest aus.	
3. Das Keypad ist betriebsbereit, wenn es das Hauptmenü anzeigt.	Wenn Sie das Keypad zum ersten Mal in Betrieb nehmen, werden Sie aufgefordert, die Dialogsprache zu wählen.
4. Sie können jetzt mit dem Grundgerät kommunizieren.	Wie Sie durch die Menüs navigieren und wie Sie Parameter ansehen und verändern können, erfahren Sie hier: 13

Anzeige-Elemente und Funktionstasten

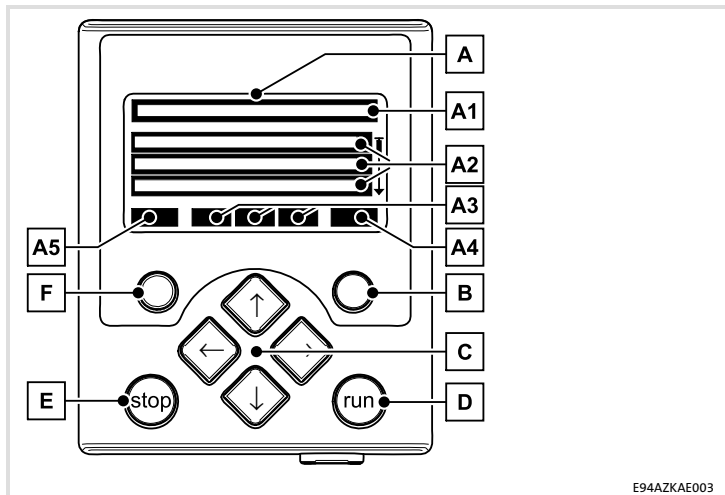

E94AZKAE003







Anzeige	Bedeutung	Bemerkung
A	LCD-Anzeige	
A1	Titelzeile	
	<MMM> Bedeutung des Menüs	Nur in der Menü-Ebene
	<PPP> Bedeutung des Parameters	Nur in der Parameter-Ebene
A2	Dreizeilige Anzeige	
	<M1> <M2> <...>	Liste der verfügbaren Menüs Nur in der Menü-Ebene
	<P1> <P2> <...>	Liste der verfügbaren Parameter Nur in der Parameter-Ebene
	<xxx>	Einstellungen des ausgewählten Parameters



4 Bedienung

Anzeige-Elemente und Funktionstasten

Anzeige	Bedeutung	Bemerkung
A3	Status des Grundgeräts	
RDY	Das Grundgerät ist betriebsbereit.	
RUN	Das Grundgerät ist freigegeben.	
STP	Applikation im Grundgerät ist gestoppt.	
QSP	Schnellhalt aktiv	
CINH	Das Grundgerät ist gesperrt.	Die Leistungsausgänge sind gesperrt.
OFF	Das Grundgerät ist einschaltbereit.	
Mmax	Drehzahlregler 1 in der Begrenzung	Der Antrieb ist drehmomentgeführt.
I_{max}	Eingestellte Stromgrenze motorisch oder generatorisch überschritten	
IMP	Impulssperre aktiv	Die Leistungsausgänge sind gesperrt.
IS_{FLT}	Systemfehler aktiv	
IFLT	Fehler aktiv	
ITRB	Störung aktiv	
IT_{QSP}	Schnellhalt durch Störung aktiv	
WRN	Warnung aktiv	
A4	Aktuelle Funktion der rechten Funktionstaste	
OK	Änderungen bestätigen und übernehmen	
HELP	Hilfe aufrufen	Wird nur angezeigt, wenn eine ausführliche Hilfe vorhanden ist.
NEXT	Zur nächsten Seite blättern.	

Anzeige	Bedeutung	Bemerkung
A5	Aktuelle Funktion der linken Funktionstaste	
	Zurück zum Hauptmenü	
SAVE	Parametersatz im Grundgerät nicht-flüchtig speichern.	
EDIT	Parameter verändern	
ESC	Aktion abbrechen, ohne die Änderung zu übernehmen.	
PREV	Zur vorhergehenden Seite blättern.	
PLC!!	Parameter kann nur geändert werden, wenn die Applikation des Grundgeräts gestoppt ist.	
CINH!!	Parameter kann nur geändert werden, wenn das Grundgerät gesperrt ist.	

Taste	Funktion	Bemerkung
B 	Die im Feld A4 angezeigte Funktion ausführen.	
D 	Die Funktion der Taste  aufheben. Die LED in der Taste  erlischt.	
E 	Die in C00469 im Menü "Keypad" ausgewählte Funktion ausführen. Die LED in der Taste leuchtet.	Lenze-Einstellung: Schnellhalt aktivieren.
F 	Die im Feld A5 angezeigte Funktion ausführen.	

Taste	Funktion				
	Menü-Ebene		Parameter-Ebene		
	Hauptmenü	Untermenü	Übersicht (9400)	Detail	Editiermodus
C 	Menü auswählen	Untermenü auswählen	Parameter auswählen		Markierte Ziffer ändern
	Zum Untermenü	Zur Parameter-Ebene	Zur Detailansicht		Cursor nach rechts
		Zurück zum Hauptmenü	Zurück zur Menü-Ebene	Zurück zur Übersicht	Cursor nach links

4 Bedienung

Menüstruktur

Menüstruktur

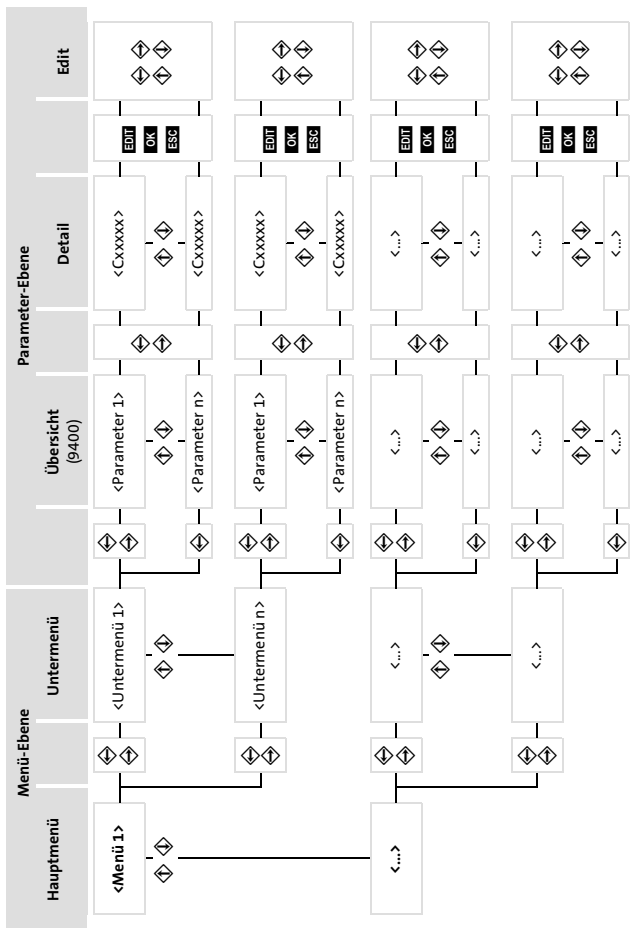

Im Hauptmenü finden Sie das selbsterklärende Menü "Keypad".



Im Menü "Keypad" finden Sie Parameter, mit denen Sie das Keypad auf Ihre Bedürfnisse anpassen können:

- ▶ Einstellungen für die LCD-Anzeige:
 - Dauer und Helligkeit der Hintergrundbeleuchtung
 - Kontrast
- ▶ Startwerte:
 - Anzeige nach der Initialisierung
 - Anzeige von Fehlermeldungen
 - Darstellung ganzer Zahlen
- ▶ Funktion der STOP-Taste

Im Menü "Keypad" können Sie auch Statusinformationen des Keypad abrufen:

- ▶ Herstellungsdaten
- ▶ Hardwarestand und Softwarestand
- ▶ Seriennummer

Elements on the front

Pos.	Description
A	LCD display
B	Right function key
C	Navigation keys 
D	 key
E	 key
F	Left function key

Elements on the back side

Pos.	Description
G	Lock hook
H	Release button
X6	RJ69 connector, connection on diagnostic interface (X6) on the basic device

Mounting

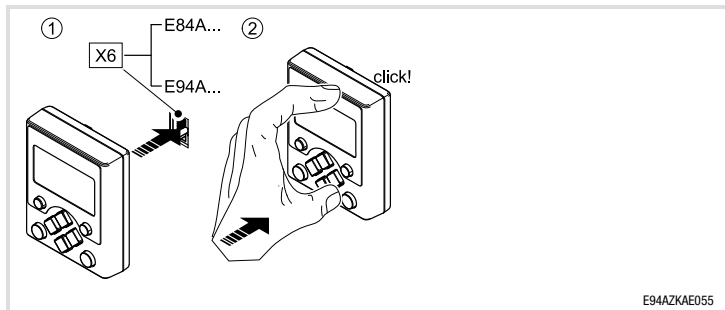

E94AZKAE055

Dismounting

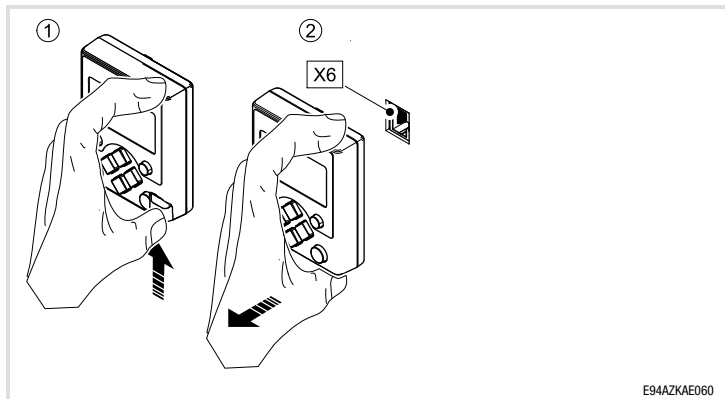

E94AZKAE060

Validity

These instructions are valid for

► Keypad, type EZAEBK100x as of version HW: VA, SW: 02.00

Identification

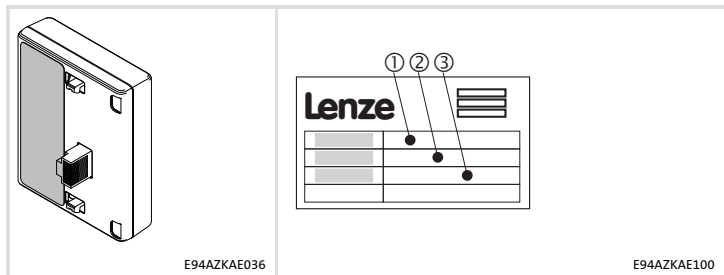

	①				②	③	
	EZ	AE	B	K	100x	xx	xx
Product range: accessories							
Design AE = display unit							
Version							
Module type: keypad							
Hardware version							
Software version							

Application range

The use of this module is permissible with basic devices as of nameplate designation:

Product range	Type	HW Ver.	SW Ver.
Servo Drives 9400	E94AxxExxxx	VB	01.10
Inverter Drives 8400	E84AxxxExxxxxxxxx	VA	00.07



Tip!

Documentation and software updates for further Lenze products can be found on the Internet in the "Services & Downloads" area under <http://www.Lenze.com>

1	Safety instructions	23
	Definition of notes used	23
	General safety information	24
2	Technical data	25
3	Commissioning	26
4	Operation	27
	Display elements and function keys	27
	Menu structure	30
5	Configuration	31

Definition of notes used

The following pictographs and signal words are used in this documentation to indicate dangers and important information:

Safety instructions

Structure of safety instructions:



Danger!

(characterises the type and severity of danger)

Note



(describes the danger and gives information about how to prevent dangerous situations)

Pictograph and signal word	Meaning
Danger!	<p>Danger of personal injury through dangerous electrical voltage. Reference to an imminent danger that may result in death or serious personal injury if the corresponding measures are not taken.</p>
Danger!	<p>Danger of personal injury through a general source of danger. Reference to an imminent danger that may result in death or serious personal injury if the corresponding measures are not taken.</p>
Stop!	<p>Danger of property damage. Reference to a possible danger that may result in property damage if the corresponding measures are not taken.</p>

1 Safety instructions

General safety information

Application notes

Pictograph and signal word	Meaning
 Note!	Important note to ensure troublefree operation
 Tip!	Useful tip for simple handling
	Reference to another documentation

General safety information



Danger!

Improper use of the module and the standard device may cause serious injury and property damage.

Observe the chapters "Safety instructions" and "Residual hazards" contained in the instructions for the standard device.

Field	Values
Enclosure	IP20
Ambient temperature	In operation: -10 °C ... +55 °C Transport: -25 °C ... +70 °C Storage: -25 °C ... +55 °C
Climatic conditions	Class 3K3 in accordance with EN 50178 (without condensation, average relative humidity 85 %)
Degree of pollution	EN 61800-5-1, degree of pollution 2

3 Commissioning

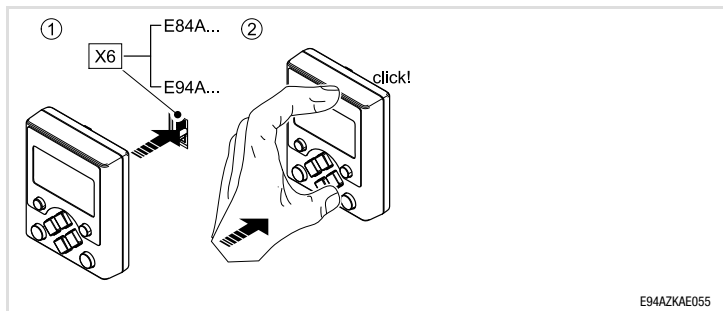

Step-by-step commissioning

Commissioning step	Comment
1. Connect keypad to the front side of the basic device on the diagnostic interface X6.	You can also connect or remove the keypad during operation.
2. If the keypad is supplied with voltage, it carries out a short self test.	
3. The keypad is ready for operation if it displays the main menu.	If you commission the keypad for the first time, you are requested to select the dialog language.
4. You can now communicate with the basic device.	How to navigate through the menus and how to view and alter parameters can be learned here:  27

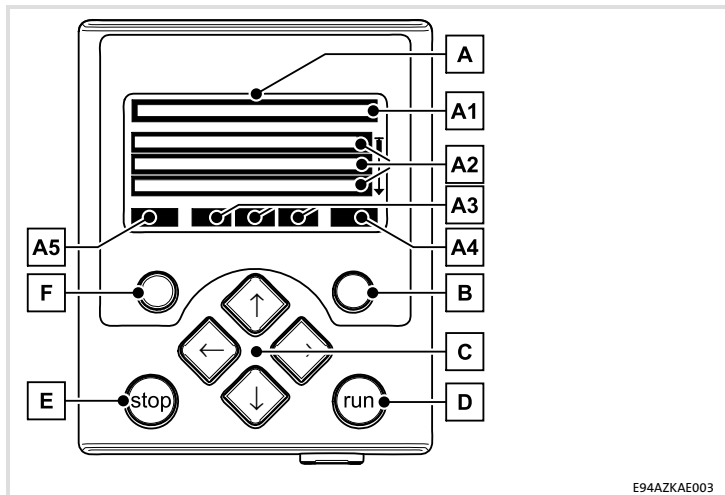
Display elements and function keys



E94AZKAE003







Display	Meaning	Comment
A	LCD display	
A1	Headline	
<MMM>	Meaning of the menu	In the menu level only
<PPP>	Meaning of the parameter	In the parameter level only
A2	Triple-spaced display	
<M1> <M2> <...>	List of the menus available	In the menu level only
<P1> <P2> <...>	List of the parameters available	In the parameter level only
<xxx>	Setting of the selected parameter	



4 Operation

Display elements and function keys

Display	Meaning	Comment
A3	Status of the basic device	
RDY	The basic device is ready for operation.	
RUN	The basic device is enabled.	
STP	Application in the basic device is stopped.	
QSP	Quick stop active	
CINH	The basic device is inhibited.	The power outputs are inhibited.
OFF	The basic device is ready to start.	
Mmax	Speed controller 1 in the limitation	The drive is torque-controlled.
I_{max}	Set current limit exceeded in motor or generator mode	
IMP	Pulse inhibit active	The power outputs are inhibited.
IS_{err}	System error active	
IFLT	Error active	
ITRB	Fault active	
IT_{QSP}	Quick stop by trouble active	
WRN	Warning active	
A4	Current function of the right function key	
OK	Confirm and accept changes	
HELP	Call up help	Is only displayed if a detailed help is available.
NEXT	Browse to the next page.	

Display	Meaning	Comment
A5	Current function of the left function key	
	Back to the main menu	
SAVE	Save parameter set in the drive non-volatily.	
EDIT	Alter parameter	
ESC	Cancel action without accepting the change.	
PREV	Browse to the previous page.	
PLC!!	Parameter can only be altered if the application of the basic device is stopped.	
CINH!!	Parameter can only be altered if the basic device is inhibited.	

Key	Function	Comment
B 	Carry out the function indicated in the field A4.	
D 	Deactivate the function of the  key. The LED in the  key goes out.	
E 	Carry out the function selected in C00469 in the "Keypad" menu. The LED in the key is on.	Lenze setting: activate quick stop.
F 	Carry out the function indicated in the field A5.	

Key	Function				
	Menu level		Parameter level		
	Main menu	Submenu	Overview (9400)	Detail	Editing mode
C 	Select menu	Select submenu	Select parameter		Alter selected digit
	To the submenu	To the parameter level	To the detail view		Cursor to the right
		Back to the main menu	Back to the menu level	Back to the overview	Cursor to the left

4 Operation

Menu structure

Menu structure

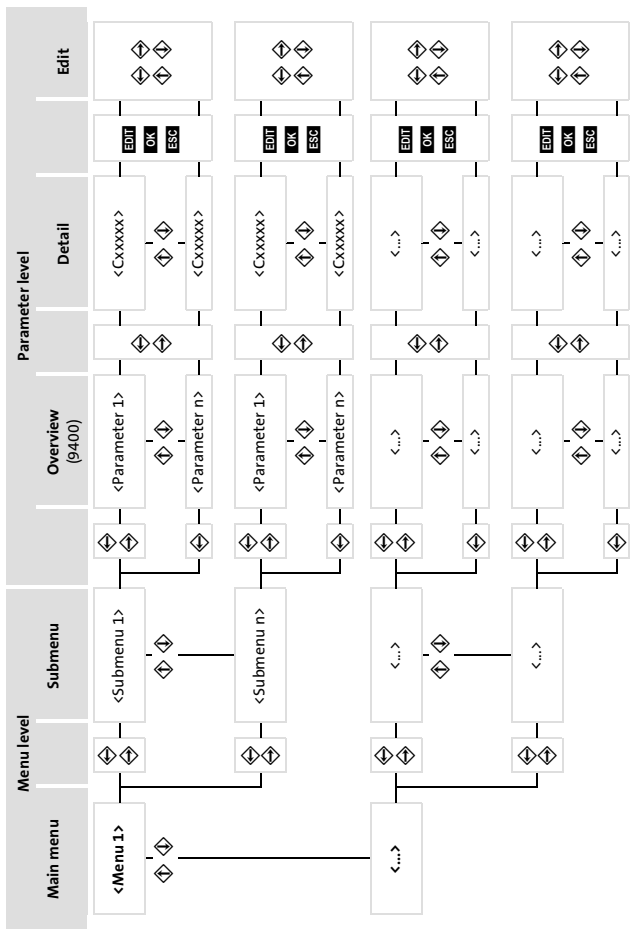

In the main menu, you'll find the self-explanatory "Keypad" menu.



In the "Keypad" menu, you'll find parameters by means of which you can adapt the keypad to your needs:

- ▶ Settings for the LCD display:
 - Duration and brightness of the background lighting
 - Contrast
- ▶ Starting values:
 - Display after the initialisation
 - Display of error messages
 - Representation of integers
- ▶ Function of the STOP key

In the "Keypad" menu, you can also call up status information on the keypad:

- ▶ Manufacturing data
- ▶ Hardware version and software version
- ▶ Serial number

Éléments à l'avant

Pos.	Description
A	Afficheur LCD
B	Touche de fonction droite
C	Touches de navigation 
D	Touche 
E	Touche 
F	Touche de fonction gauche

Éléments à l'arrière

Pos.	Description
G	Crochet de verrouillage
H	Bouton de déverrouillage
X6	Connecteur à fiches RJ69, raccordement à l'interface de diagnostic (X6) de l'appareil de base

Montage

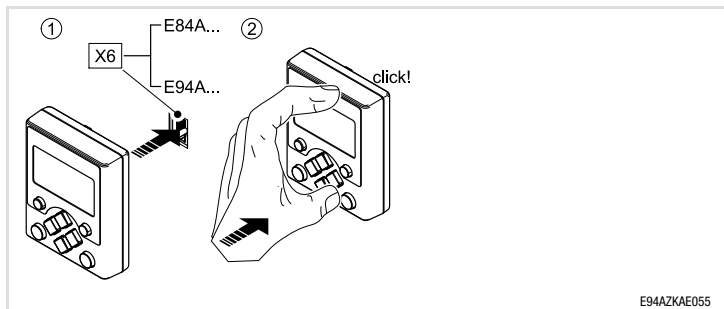

Démontage

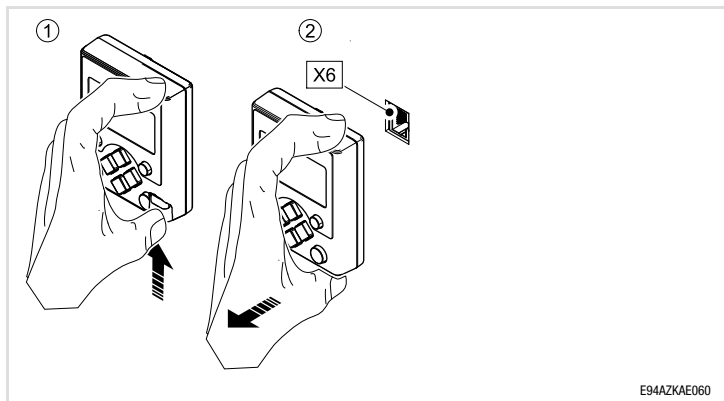

Validité

Le présent document s'applique au produit suivant :

- Clavier de commande, type EZAEBK100x, à partir de la version matérielle VA et de la version logicielle 02.00

Identification

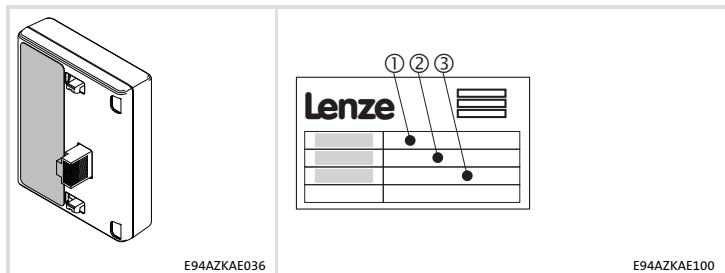

	①				②	③	
	EZ	AE	B	K	100x	xx	xx
Famille de produits : accessoire							
Version AE = afficheur							
Génération d'appareils							
Type de module : clavier de commande							
Version matérielle							
Version logicielle							

Utilisation

Ce module est compatible avec les appareils de base dont la plaque signalétique comporte les mentions suivantes :

Série	Type	HW Ver.	SW Ver.
Servo Drives 9400	E94AxxExxxx	VB	01.10
Inverter Drives 8400	E84AxxxExxxxxxxxx	VA	00.07



Conseil !

Les mises à jour de logiciels et les documentations relatives aux produits Lenze sont disponibles dans la zone "Téléchargements" du site Internet :

<http://www.Lenze.com>

1	Consignes de sécurité	37
	Définition des conventions utilisées	37
	Consignes générales	38
2	Spécifications techniques	39
3	Mise en service	40
4	Utilisation	41
	Éléments d'affichage et touches de fonction	41
	Structure du menu	44
5	Configuration	45

Définition des conventions utilisées

Pour indiquer des risques et des informations importantes, la présente documentation utilise les mots et symboles suivants :

Consignes de sécurité

Présentation des consignes de sécurité





Danger !

(Le pictogramme indique le type de risque.)

Explication



(L'explication décrit le risque et les moyens de l'éviter.)

Pictogramme et mot associé	Explication
 Danger !	<p>Situation dangereuse pour les personnes en raison d'une tension électrique élevée</p> <p>Indication d'un danger imminent qui peut avoir pour conséquences des blessures mortelles ou très graves en cas de non-respect des consignes de sécurité correspondantes</p>
 Danger !	<p>Situation dangereuse pour les personnes en raison d'un danger d'ordre général</p> <p>Indication d'un danger imminent qui peut avoir pour conséquences des blessures mortelles ou très graves en cas de non-respect des consignes de sécurité correspondantes</p>
 Stop !	<p>Risques de dégâts matériels</p> <p>Indication d'un risque potentiel qui peut avoir pour conséquences des dégâts matériels en cas de non-respect des consignes de sécurité correspondantes</p>

1 Consignes de sécurité

Consignes générales

Consignes d'utilisation

Pictogramme et mot associé	Explication
 Remarque importante !	Remarque importante pour assurer un fonctionnement correct
 Conseil !	Conseil utile pour faciliter la mise en oeuvre
	Référence à une autre documentation

Consignes générales



Danger !

Toute utilisation contre-indiquée du module et de l'appareil de base risque d'entraîner des dommages corporels et matériels graves.

Tenir compte des consignes de sécurité et des dangers résiduels décrits dans la documentation de l'appareil de base concerné.

Critère	Valeurs
Indice de protection	IP20
Température ambiante	Fonctionnement : -10 °C ... +55 °C Transport : -25 °C ... +70 °C Stockage : -25 °C ... +55 °C
Conditions climatiques	Classe 3K3 selon EN 50178 (sans condensation, humidité relative moyenne : 85 %)
Pollution ambiante admissible	Degré 2 selon EN 61800-5-1

3 Mise en service

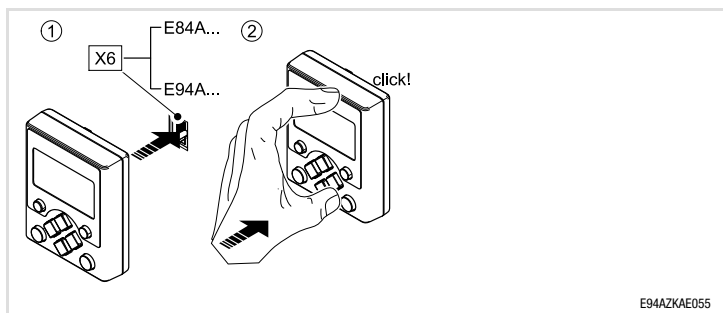

E94AZKAE055

Etapes de la mise en service

Etape de la mise en service	Remarque
1. Raccorder le clavier de commande sur la face avant de l'appareil de base à l'interface de diagnostic X6.	Le clavier de commande peut être raccordé et retiré pendant le fonctionnement de l'appareil.
2. Lorsque le clavier de commande est sous tension, un bref autotest est exécuté.	
3. Le clavier de commande est opérationnel lorsque le menu principal s'affiche.	Lors de la première utilisation du clavier de commande, l'utilisateur est invité à sélectionner la langue utilisé pour les boîtes de dialogue.
4. La communication avec l'appareil de base peut à présent être réalisée.	Pour naviguer au sein des menus et consulter ou modifier les paramètres, lire 41

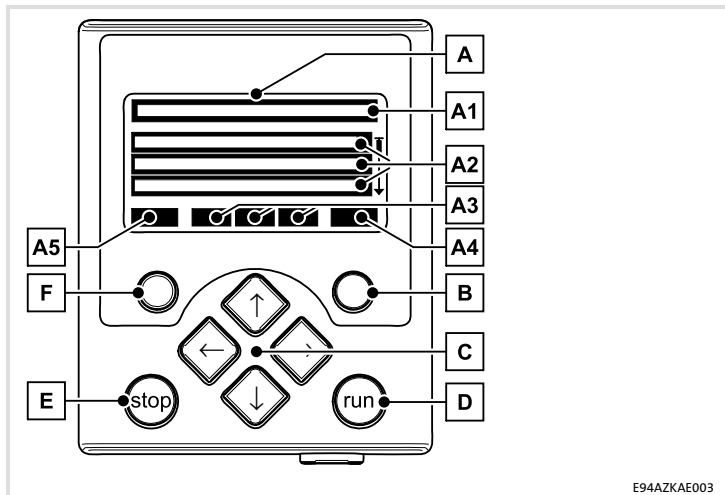
Éléments d'affichage et touches de fonction

E94AZKAE003

Affichage	Signification	Remarque
A	Afficheur LCD	
A1	Ligne de titre	
<MMM>	Intitulé du menu	Mode Menu uniquement
<PPP>	Intitulé du paramètre	Mode Paramètres uniquement
A2	Affichage sur trois lignes	
<M1> <M2> <...>	Liste des menus disponibles	Mode Menu uniquement
<P1> <P2> <...>	Liste des paramètres disponibles	Mode Paramètres uniquement
<xxx>	Réglages du paramètre sélectionné	

4 Utilisation

Éléments d'affichage et touches de fonction

Affichage	Signification	Remarque
A3	Etat de l'appareil de base	
RDY	Appareil de base opérationnel	
RUN	Appareil de base débloqué	
STP	Application en cours d'exécution dans l'appareil de base interrompue	
QSP	Arrêt rapide activé	
CINH	Appareil de base bloqué	Sorties de puissance bloquées
OFF	Appareil de base prêt à fonctionner	
M_{max}	Limite du régulateur de vitesse 1 atteinte	Commande par couple de l'entraînement
I_{max}	Limite de courant moteur ou générateur réglée dépassée	
IMP	Blocage d'impulsions activé	Sorties de puissance bloquées
ISysT	Erreur système activée	
IFLT	Erreur activée	
ITRB	Mise en défaut	
ITOSP	Arrêt rapide suite à la mise en défaut	
WRN	Avertissement activé	
A4	Fonction actuelle de la touche de fonction droite	
OK	Confirmer et appliquer les modifications	
HELP	Affichage de l'aide	Disponible uniquement si une aide détaillée est disponible
NEXT	Page suivante	

Affichage	Signification	Remarque
A5	Fonction actuelle de la touche de fonction gauche	
	Revenir au menu principal	
SAVE	Enregistrer le jeu de paramètres dans la mémoire non volatile de l'appareil de base	
EDIT	Modifier le paramètre	
ESC	Annuler l'opération sans appliquer les modifications	
PREV	Page précédente	
PLC!!	Paramètre modifiable uniquement si l'application en cours d'exécution dans l'appareil de base est interrompue	
CINH!!	Paramètre modifiable uniquement si l'appareil de base est bloqué	

Touche	Fonction	Remarque
B	Exécuter la fonction affichée sous A4.	
D	Suspendre la fonction de la touche . Le voyant (LED) de la touche s'éteint.	
E	Exécuter la fonction sélectionnée dans le menu "Keypad" sous C00469. Le voyant (LED) de la touche s'éteint.	Réglage Lenze : Activer l'arrêt rapide.
F	Exécuter la fonction affichée sous A5.	

Touche	Fonction				
	Mode Menu		Mode Paramètres		
	Menu principal	Sous-menu	Aperçu (9400)	Détail	Mode Edition
C	Sélectionner un menu	Sélectionner un sous-menu	Sélectionner un paramètre		Modifier le chiffre sélectionné
		Afficher le sous-menu	Passer en mode Paramètres	Afficher la vue détaillée	Curseur vers la droite
			Revenir au menu principal	Repasser en mode Menu	Revenir à l'aperçu

4 Utilisation

Structure du menu

Structure du menu

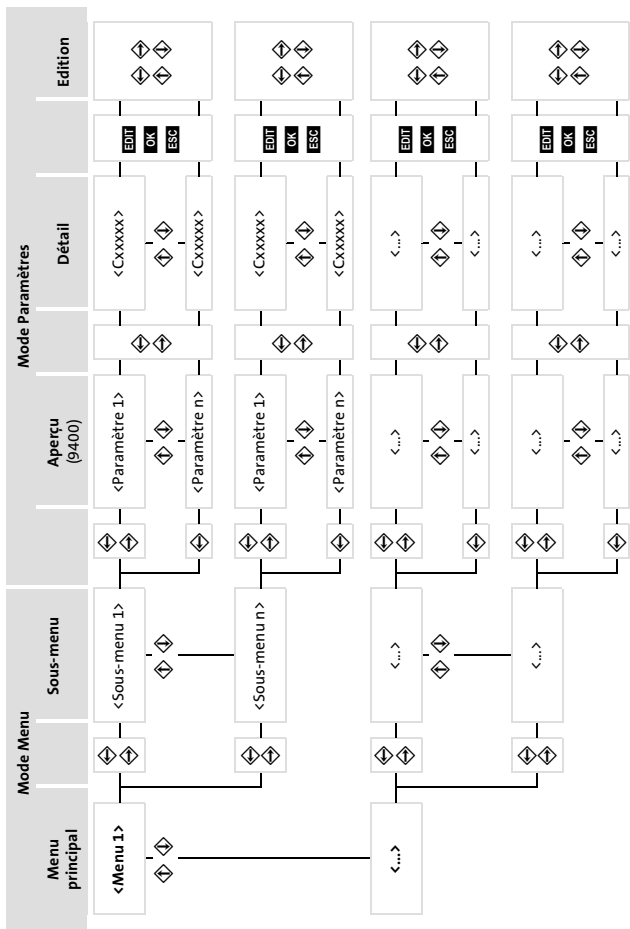

Le menu principal contient le sous-menu "Keypad".



Celui-ci contient les paramètres permettant d'adapter le clavier de commande aux besoins de l'utilisateur :

- ▶ Réglages pour affichage LCD :
 - Durée et intensité du rétro-éclairage
 - Contraste
- ▶ Valeurs par défaut :
 - Affichage après initialisation
 - Affichage de messages d'erreur
 - Représentation de nombres entiers
- ▶ Fonction de la touche STOP

Le menu "Keypad" permet également de consulter les informations relatives à la version du clavier de commande :

- ▶ Données du constructeur
- ▶ Versions matérielle et logicielle
- ▶ Numéro de série

Elementos en la parte delantera

Pos.	Descripción
A	Pantalla LCD
B	Tecla de función derecha
C	Teclas de navegación 
D	Tecla 
E	Tecla 
F	Tecla de función izquierda

Elementos en la parte trasera

Pos.	Descripción
G	Enganche de sujeción
H	Botón de apertura
X6	Conector RJ69, conexión a interface de diagnóstico (X6) del equipo básico

Montaje

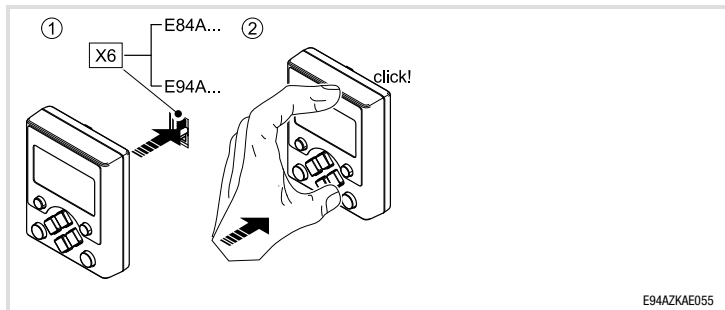

Desmontaje

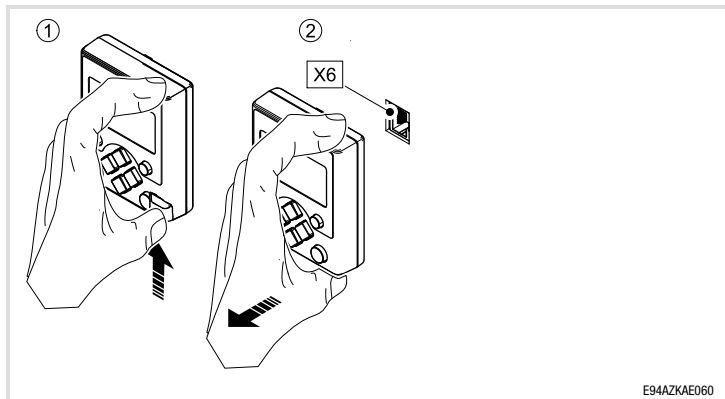

Validez

Este manual es de aplicación para

- Keypad, tipo EZAEBK100x a partir de la versión de hardware : VA, versión de software: 02.00

Identificación

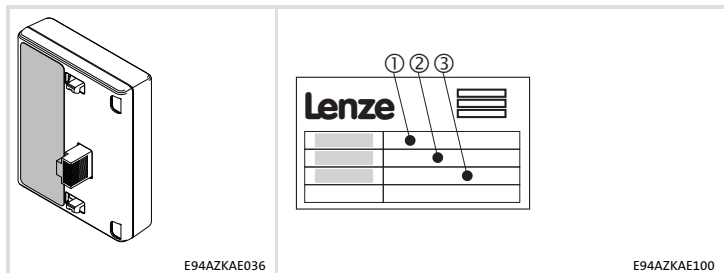

	①				②	③	
	EZ	AE	B	K	100x	xx	xx
Serie de productos: accesorio							
Ejecución AE = unidad de visualización							
Versión de equipos							
Tipo de módulo: keypad							
Versión de hardware							
Versión de software							

Posibilidades de uso

Este módulo se puede utilizar solamente con los equipos básicos a partir de la siguiente versión:

Serie de productos	Type	HW Ver.	SW Ver.
Servo Drives 9400	E94AxxExxxx	VB	01.10
Inverter Drives 8400	E84AxxxExxxxxxxxxx	VA	00.07



¡Sugerencia!

Encontrará documentación y actualizaciones de software para otros productos de Lenze en la sección «Servicios y descargas» de nuestra página web.

<http://www.Lenze.com>

i Contenido

1	Instrucciones de seguridad	51
	Definición de las instrucciones utilizadas	51
	Instrucciones generales de seguridad	52
2	Datos técnicos	53
3	Puesta en marcha	54
4	Operación	55
	Elementos de visualización y teclas de función	55
	Estructura de menú	58
5	Configuración	59

Definición de las instrucciones utilizadas

Para indicar peligros e información importante, se utilizan en esta documentación los siguientes términos indicativos y símbolos:

Instrucciones de seguridad

Estructura de las instrucciones de seguridad:





¡Peligro!



(indican el tipo y la gravedad del peligro)

Texto indicativo

(describe el peligro y da instrucciones para evitarlo)

Pictograma y término indicativo	Significado
 ¡Peligro!	Riesgo de daños personales por voltaje eléctrico Indica un peligro inminente que puede causar la muerte o lesiones graves si no se toman las medidas adecuadas.
 ¡Peligro!	Riesgo de daños personales por una fuente de riesgo general Indica un peligro inminente que puede causar la muerte o lesiones graves si no se toman las medidas adecuadas.
 ¡Alto!	Peligro de daños materiales Indica un posible riesgo que puede ocasionar daños materiales si no se toman las medidas adecuadas.

Instrucciones de uso

Pictograma y término indicativo	Significado
 ¡Aviso!	Nota importante para el funcionamiento sin fallos
 ¡Sugerencia!	Sugerencia útil para facilitar la operación
	Referencia a otra documentación

1 Instrucciones de seguridad

Instrucciones generales de seguridad



¡Peligro!

La manipulación inadecuada del módulo y del equipo básico puede ocasionar graves daños personales y materiales.

Observe siempre las instrucciones de seguridad y sobre peligros residuales incluidas en las instrucciones del equipo básico.

Ámbito	Valores
Protección	IP20
Temperatura ambiente	En funcionamiento: -10 °C ... +55 °C Transporte: -25 °C ... +70 °C Almacenamiento: -25 °C ... +55 °C
Condiciones climatológicas	Clase 3K3 según EN 50178 (sin condensación, humedad relativa media 85 %)
Grado de polución	EN 61800-5-1, grado de polución 2

3 Puesta en marcha

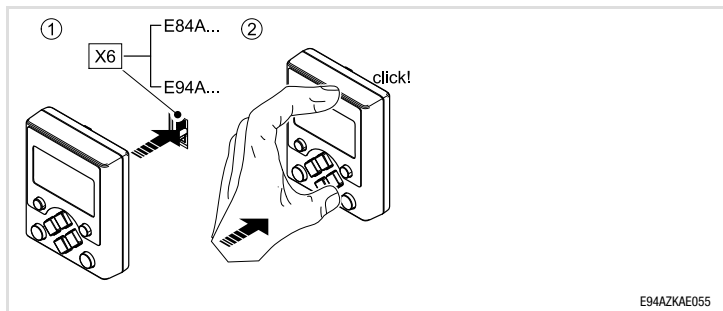

E94AZKAE055

Pasos para la puesta en marcha

Paso para la puesta en marcha	Comentario
1. Conectar keypad el interface diagnóstico X6 que se encuentra en la parte frontal del equipo básico.	El keypad también se puede conectar y retirar mientras el equipo está en funcionamiento.
2. Si el keypad está siendo alimentado con voltaje realizará un breve autotest.	
3. El keypad está listo para operar cuando muestra el menú principal.	Quando el keypad se pone en marcha por primeravez , el equipo le solicitará seleccionar el idioma deseado para el diálogo.
4. Ahora está listo para comunicar con el equipo básico.	La información sobre cómo navegar en los menús y cómo visualizar y modificar parámetros se encuentra aquí:  55

Elementos de visualización y teclas de función

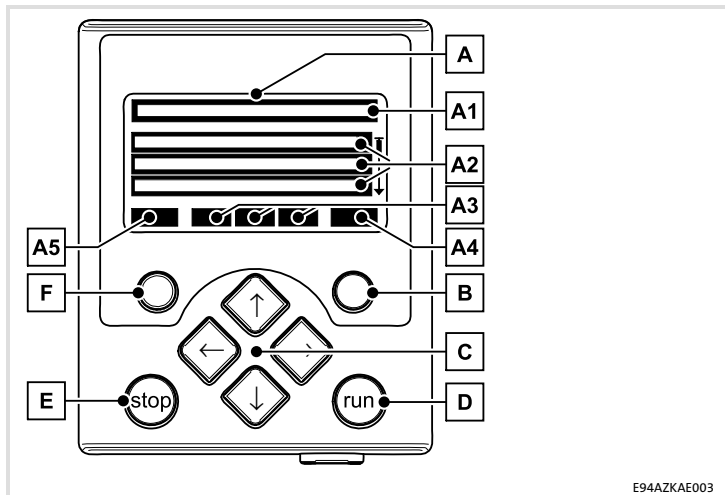







Display	Significado	Comentario
A	Pantalla LCD	
A1	Título	
	<MMM> Significado del menú	Sólo en el nivel de menú
	<PPP> Significado del parámetro	Sólo en el nivel de parámetros
A2	Tres líneas de indicación	
	<M1> <M2> <...>	Sólo en el nivel de menú
	<P1> <P2> <...>	Sólo en el nivel de parámetros
	<xxx> Configuraciones del parámetro seleccionado	



4 Operación

Elementos de visualización y teclas de función

Display	Significado	Comentario	
A3	Estado del equipo básico		
	RDY	El equipo básico está listo para operar.	
	RUN	El equipo básico está habilitado.	
	STP	La aplicación ha sido detenida en el equipo básico.	
	QSP	Parada rápida activada	
	CINH	El equipo básico está inhibido.	Las salidas de potencia están inhibidas.
	OFF	El equipo básico está listo para conectar.	
	Mmax	Se ha alcanzado el límite de par	El accionamiento está siendo controlado por par.
	I_{max}	El límite de intensidad configurado se ha superado en modo motor o generador	
	IMP	Inhibición de impulsos activada	Las salidas de potencia están inhibidas.
	IS_{FLT}	Error de sistema activo	
	IFLT	Error activo	
	ITRB	Fallo activo	
ITQSP	Parada rápida por fallo activa		
WRN	Advertencia activa		
A4	Función actual de la tecla de función derecha		
	OK	Confirmar cambios y aceptarlos	
	HELP	Solicitar ayuda	Sólo se muestra si se dispone de ayuda detallada.
	NEXT	Pasar a la siguiente página.	

Display	Significado	Comentario
A5	Función actual de la tecla de función izquierda	
	Volver al menú principal	
SAVE	Guardar el conjunto de parámetros en la memoria no volátil del equipo básico.	
EDIT	Modificar parámetro	
ESC	Interrumpir acción sin aceptar el cambio.	
PREV	Volver a la página anterior.	
PLCI!	El parámetro sólo se puede modificar cuando se detiene la aplicación del equipo básico.	
CINH!	El parámetro sólo se puede modificar cuando el equipo básico está inhibido.	

Tecla	Función	Comentario
B 	Ejecutar la función indicada en el campo A4.	
D 	Suprimir la función de la tecla  . El LED de la tecla  se apaga.	
E 	Ejecutar la función seleccionada bajo el código del menú "Keypad". El LED en la tecla se enciende.	Configuración de Lenze: Activar parada rápida.
F 	Ejecutar la función indicada en el campo A5.	

Tecla	Función				
	Nivel menú		Nivel parámetro		
	Menú principal	Submenú	Vista general (9400)	Detalle	Modo edición
C 	Seleccionar menú	Seleccionar submenú	Seleccionar parámetro		Modificar cifra marcada
	Ir al submenú	Ir al nivel de parámetros	Ir a la presentación detallada		Cursor a la derecha
		Volver al menú principal	Volver al nivel de menú	Volver a la vista general	Cursor a la izquierda

4 Operación

Estructura de menú

Estructura de menú

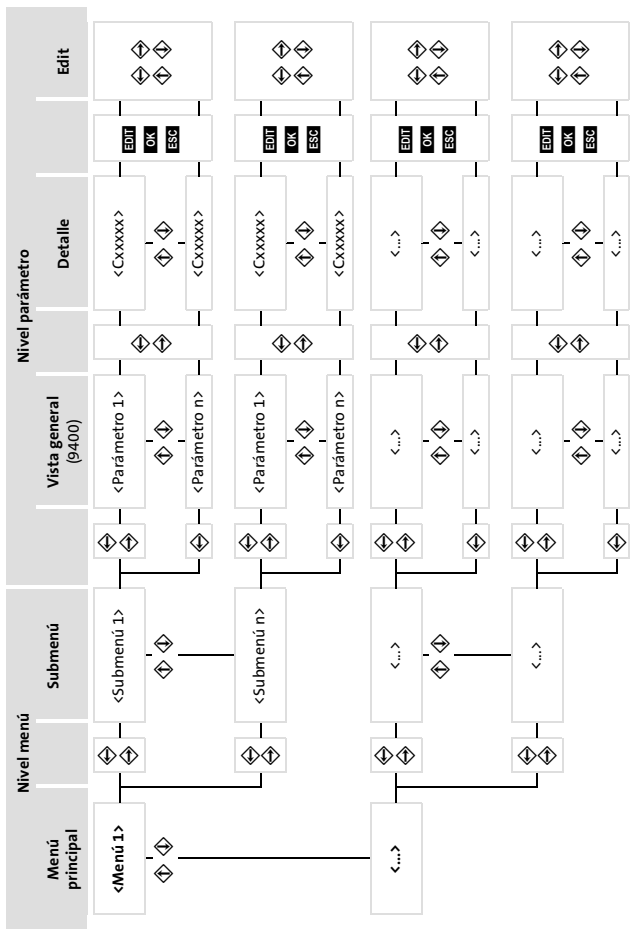

En el menú principal se encuentra el menú autoexplicativo "Keypad".



En el menú "Keypad" se encuentran los parámetros con los que se podrá adaptar el keypad a las necesidades correspondientes:

- ▶ Configuraciones para la pantalla LCD:
 - Duración y claridad de la iluminación de fondo
 - Contraste
- ▶ Valores iniciales:
 - Visualización tras la inicialización
 - Visualización de mensajes de error
 - Presentación de números enteros
- ▶ Función de la tecla STOP

En el menú "Keypad" también se pueden consultar informaciones sobre el estado del Keypad:

- ▶ Datos de fabricación
- ▶ Versión de hardware y de software
- ▶ Número de serie

Elementi sul lato anteriore

Pos.	Descrizione
A	Display LCD
B	Tasto funzione destro
C	Tasti di navigazione 
D	Tasto 
E	Tasto 
F	Tasto funzione sinistro

Elementi sul lato posteriore

Pos.	Descrizione
G	Ganci di bloccaggio
H	Manopola di sblocco
X6	Connettore RJ69, collegamento all'interfaccia di diagnostica (X6) sul modulo asse

Montaggio

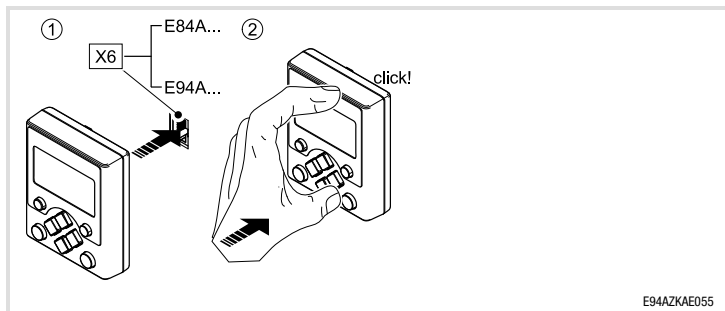

Smontaggio

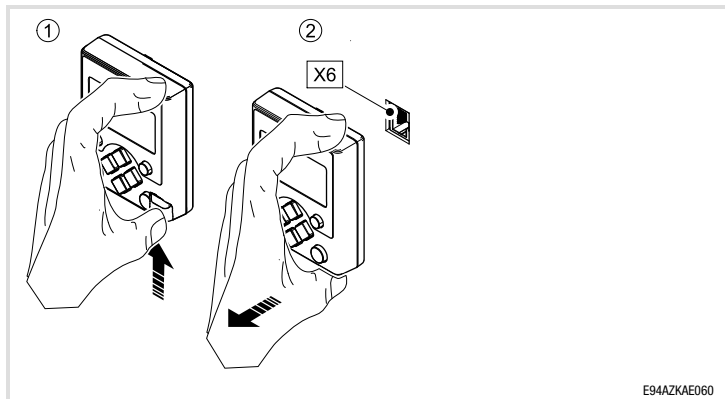

Validità

La presente documentazione è valida per

► Tastiera, tipo EZAEBK100x a partire dalla versione HW: VA, SW: 02.00

Identificazione

E94AZKAE036

E94AZKAE100

①					②	③
EZ	AE	B	K	100x	xx	xx

Serie prodotto: Accessorio

Esecuzione
AE = unità con display

Versione

Tipo di modulo: Tastiera

Versione hardware

Versione software

Compatibilità

L'utilizzo di questo modulo è consentito con dispositivi di base a partire dalla versione seguente (v. targhetta):

Serie	Type	HW Ver.	SW Ver.
Servo Drives 9400	E94AxxExxxx	VB	01.10
Inverter Drives 8400	E84AxxxExxxxxxxxx	VA	00.07



Suggerimento:

Per la documentazione e gli aggiornamenti software dei prodotti Lenze, consultare in Internet la sezione "Services & Downloads" all'indirizzo <http://www.Lenze.com>

i Sommario

1	Informazioni sulla sicurezza	65
	Simbologia delle note e avvertenze utilizzate	65
	Note generali di sicurezza	66
2	Dati tecnici	67
3	Messa in servizio	68
4	Utilizzo	69
	Indicatori e tasti funzione	69
	Struttura dei menu	72
5	Configurazione	73

Simbologia delle note e avvertenze utilizzate

Per segnalare pericoli ed informazioni importanti, nella presente documentazione sono riportati i seguenti simboli e parole di segnalazione:

Note di sicurezza

Struttura delle note di sicurezza:





Pericolo!



(indica il tipo e la gravità del pericolo)

Testo della nota

(descrive il pericolo e fornisce indicazioni su come può essere evitato)

Simbolo e parola di segnalazione	Significato
 Pericolo!	Pericolo di danni alle persone dovuti a tensione elettrica Segnala una situazione di pericolo che può provocare morte o gravi lesioni se non vengono osservate le necessarie misure precauzionali.
 Pericolo!	Pericolo di danni alle persone dovuti a una fonte generica di pericolo Segnala una situazione di pericolo che può provocare morte o gravi lesioni se non vengono osservate le necessarie misure precauzionali.
 Stop!	Pericolo di danni materiali Segnala un possibile pericolo che può provocare danni materiali se non vengono osservate le necessarie misure precauzionali.

Note di utilizzo

Simbolo e parola di segnalazione	Significato
 Avvertenza:	Avvertenza importante per assicurare un corretto funzionamento dell'apparecchiatura
 Suggerimento:	Utile suggerimento per un più semplice utilizzo
	Rimando ad altra documentazione

1 Informazioni sulla sicurezza

Note generali di sicurezza

Note generali di sicurezza



Pericolo!

L'utilizzo non conforme del modulo e del modulo asse può provocare gravi danni a persone e cose.

Osservare le note di sicurezza e pericolo contenute nel manuale del modulo asse.

Campo	Valori
Grado di protezione	IP20
Temperatura ambiente	Funzionamento: -10 °C ... +55 °C Trasporto: -25 °C ... +70 °C Stoccaggio: -25 °C ... +55 °C
Condizioni climatiche	Classe 3K3 secondo EN 50178 (umidità relativa media 85 %, senza condensa)
Grado di inquinamento	EN 61800-5-1, grado di inquinamento 2

3 Messa in servizio

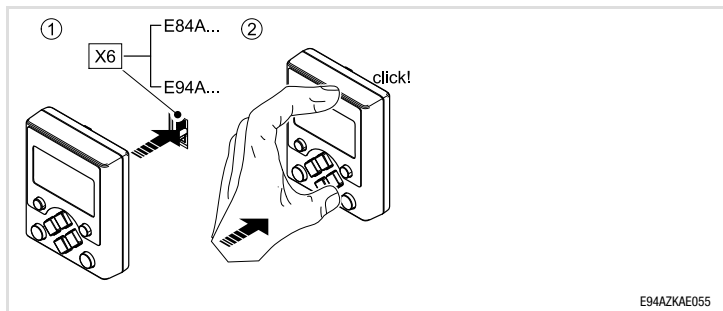

Fasi della messa in servizio

Fasi della messa in servizio		Nota
1.	Connettere la tastiera all'interfaccia di diagnostica X6, sul lato frontale del modulo asse.	La tastiera può essere collegata e rimossa anche durante il funzionamento.
2.	Quando riceve la tensione di alimentazione, la tastiera esegue un piccolo test di autodiagnostica.	
3.	La tastiera è pronta per il funzionamento quando è visualizzato il menu principale.	Durante la prima messa in servizio della tastiera viene richiesto di selezionare la lingua per i messaggi di testo.
4.	Ora è possibile comunicare con il modulo asse.	Per le istruzioni sulla navigazione tra i menu e la visualizzazione e modifica dei parametri, vedere: 69

Indicatori e tasti funzione

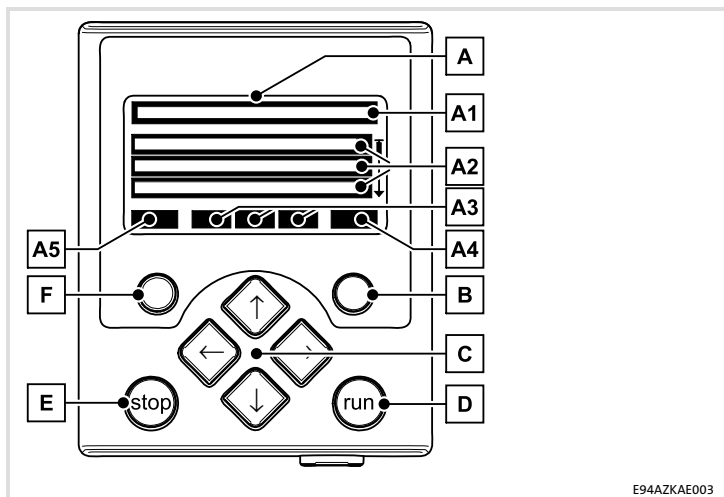

E94AZKAE003

Display	Significato	Nota
A	Display LCD	
A1	Riga del titolo	
<MMM>	Significato del menu	Solo nel livello menu
<PPP>	Significato del parametro	Solo nel livello parametri
A2	Display a tre righe	
<M1> <M2> <...>	Elenco dei menu disponibili	Solo nel livello menu
<P1> <P2> <...>	Elenco dei parametri disponibili	Solo nel livello parametri
<xxx>	Impostazioni del parametro selezionato	

4 Utilizzo

Indicatori e tasti funzione

Display	Significato	Nota
A3	Stato del modulo asse	
RDY	Il modulo asse è pronto per il funzionamento	
RUN	Il modulo asse è in funzione	
STP	Modulo asse disattivato	
QSP	Arresto rapido attivato	
CINH	Il modulo asse è inibito	Le uscite di potenza sono inibite.
OFF	Il modulo asse è pronto per l'inserzione	
Mmax	Controllo di velocità 1 in limitazione	L'azionamento è controllato dalla coppia.
I_{max}	Limite di corrente impostato in modo motore o in modo generatore superato	
IMP	Inibizione impulsi attivata	Le uscite di potenza sono inibite.
ISPLT	Errore di sistema attivato	
IFLT	Errore attivato	
ITRB	Guasto attivato	
ITOSP	Arresto rapido per guasto attivato	
WRN	Avvertenza attivata	
A4	Funzione attuale del tasto funzione destro	
OK	Conferma e applicazione modifiche	
HELP	Richiamo Guida in linea	Viene visualizzato solo quando è disponibile una Guida in linea.
NEXT	Passaggio alla pagina successiva	

Display	Significato	Nota
A5	Funzione attuale del tasto funzione sinistro	
	Indietro al menu principale	
SAVE	Salvataggio permanente del set di parametri nel modulo asse	
EDIT	Modifica parametro	
ESC	Interruzione azione, senza applicazione della modifica	
PREV	Passaggio alla pagina precedente	
PLC!!	Il parametro può essere modificato solo se il modulo asse è disattivato	
CINH!!	Il parametro può essere modificato solo se il modulo asse è inibito	

Tasto	Funzione	Nota
B	Esecuzione della funzione visualizzata nel campo A4.	
D	Interruzione della funzione del tasto . Il LED nel tasto si spegne.	
E	Esecuzione della funzione selezionata in C00469 nel menu "Keypad". Il LED nel tasto si accende.	Impostazione Lenze: Attivazione arresto rapido.
F	Esecuzione della funzione visualizzata nel campo A5.	

Tasto	Funzione				
	Livello menu		Livello parametri		
	Menu principale	Sottomenu	Panoramica (9400)	Dettaglio	Modo modifica
C	Selezione menu	Selezione sottomenu	Selezione parametro		Modifica cifra selezionata
	Al sottomenu	Al livello parametri	Alla vista di dettaglio		Cursore verso destra
		Indietro al menu principale	Indietro al livello menu	Indietro alla panoramica	Cursore verso sinistra

4 Utilizzo

Struttura dei menu

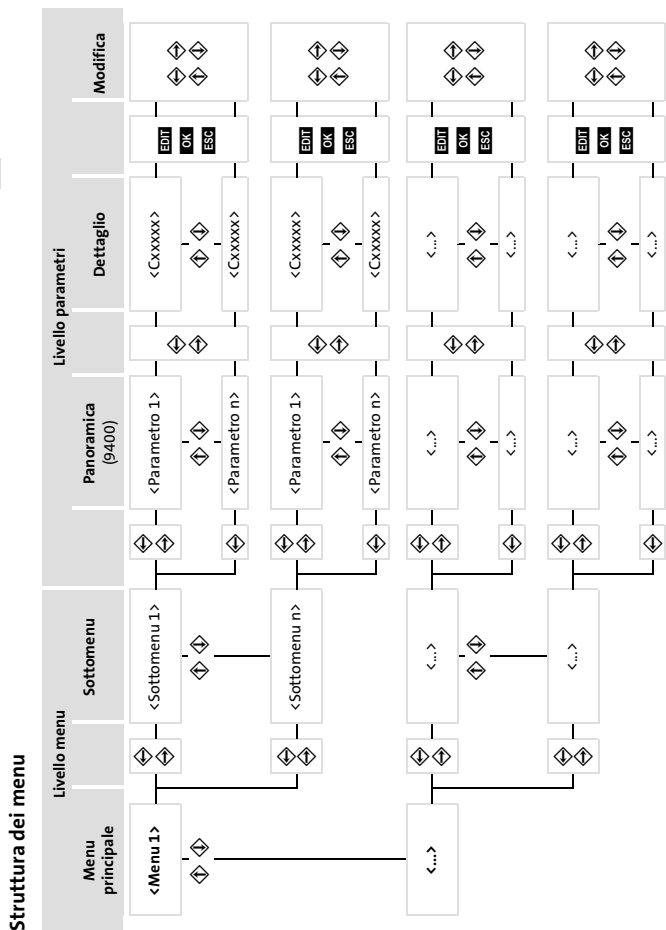

Il menu principale contiene la voce "Keypad" (tastiera).

Nel menu "Keypad" sono elencati i parametri che permettono di adattare la tastiera alle proprie esigenze:

- ▶ Impostazioni del display LCD:
 - Durata e luminosità della retroilluminazione
 - Contrasto
- ▶ Valori iniziali:
 - Visualizzazione dopo l'inizializzazione
 - Visualizzazione di messaggi di errore
 - Rappresentazione di numeri interi
- ▶ Funzione del tasto STOP

Nel menu "Keypad" è possibile anche richiamare informazioni sulla tastiera:

- ▶ Dati di produzione
- ▶ Versione hardware e versione software
- ▶ Numero di serie



© 04/2010



Lenze Automation GmbH
Hans-Lenze-Str. 1
D-31855 Aerzen
Germany



+49 (0)51 54 / 82-0



+49 (0)51 54 / 82 - 28 00



Lenze@Lenze.de



www.Lenze.com

Service Lenze Service GmbH
Breslauer Straße 3
D-32699 Extertal
Germany



00 80 00 / 24 4 68 77 (24 h helpline)



+49 (0)51 54 / 82-11 12



Service@Lenze.de

EDBZAEBK000X ■ 13282624 ■ DE/EN/FR/ES/IT ■ 2.1 ■ TD00

10 9 8 7 6 5 4 3 2 1