



X7 OCS MODEL: HE-X7

MODEL A BUILT-IN I/O: 12 DIGITAL IN, 12 DIGITAL OUT, 4 ANALOG IN/RTD IN, 2 ANALOG OUT
MODEL R BUILT-IN I/O: 12 DIGITAL IN, 6 RELAY OUT, 2 PWM OUT, 4 ANALOG IN/RTD IN, 2 ANALOG OUT

1 TECHNICAL SPECIFICATIONS

1.1 General

Primary Pwr. Range	24VDC +/- 20%
Typical power-backlight 100%	154mA @ 24V
Power Backlight Off	123mA @ 24V
Inrush Current	30A < 1ms
Real Time Clock	Battery backed; lithium coin cell CR2450
Battery Life	7 -10 years
Clock Accuracy	+/- 90 secs/month @ 20°C
Relative Humidity	5 to 95% Non-condensing
Operating Temp.	-10°C to +60°C
Storage Temp.	-20°C to +70°C
Weight	20.8 oz/ 590g
Mounting Clips	4 composite type
Housing Material	Polycarbonate, UL rated
Panel Seal	Silicone rubber
Packaging	100% Recyclable paper fiber materials
Included in Box	Controller, 3 x I/O connectors, 4 x mounting clips, 1 x power connector, Quick Reference Guide

1.2 User Interface

Display	7" 65k Color Transmissive
Resolution	800 x 480 pixels
Backlight	White LED
Backlight Lifetime	20,000 hours to reach 50% brightness
Backlight Control	Yes, software controlled (ON/OFF)
User-Programmable Screens/Pages	250
No. of Objects/Screens	30
Screen Memory	256kB
Keypad	Touchscreen
Tactile Feedback	Optional Sound
Number of Keys	Max 30 per page + touch system and four function keys

1.3 Connectivity

Serial Ports	1 x RS232, 1 x RS485
485 Terminations	On-board, software controlled
USB mini-B	Slave only
USB Programming Support	Yes
USB Type	USB 2.0
CAN Hardware	CAN 2.0
CAN Port Connector	RJ45 (Red)
CAN Port Speeds Support	125kB, 250kB, 500kB, 1Mb/sec.
CAN Port Termination	On-board, software controlled
CAN Protocols	CsCAN
Removable Memory In	microSD (SDHC, SDXC IN FAT32 format, support for 32GB max. Application Updates, Datalogging, more)

1.4 Control & Logic

Control Language Support	Advanced ladder logic Full IEC 61131-3 languages
Logic Program Size	256kB
Non-Retentive Memory	128kB
Internal Storage Memory	16Mb
Total Program Memory	2.5Mb
Logic Scan Rate	0.4ms/kB
%I (Digital Inputs)	1024
%Q (Digital Outputs)	1024
%AI (Analog Inputs)	256
%AQ (Analog Outputs)	256
%M (Retentive Bits)	1024
%T (Temporary Bits)	1024
%R (Retentive Registers)	5000
%D (Display Bits)	250
%K (Key Bit)	4
%S (Status Bits)	13
%SR (System Registers)	255

1.5 I/O Connections

Terminal Type	Removable 3.5 m color-coded
I/O Options	Onboard + Remote-SmartMod, SmartRail, SmartBlock, SmartStix

1.6 Testing

Shock	IEC 60068-2-27
Vibration	IEC 60068-2-6
UL Environmental Ratings	Type 1, 4, 4X, 12, 12k & 13 for indoor use
Certifications (UL/CE)	USA: https://hornerautomation.com/certifications/ Europe: http://www.horner-app.com/en/support/certification.aspx

1.7 Inputs/Outputs Model Overview

	MODEL R	MODEL A
DC In	12	12
DC Out	2	12
Relays	6	-
HS In	4	4
HS Out	2	2
mA In/RTD	4	4
mA Out	2	2

There are four high-speed inputs (I9-I12) of the total DC Inputs.

There are two high-speed outputs (Q1-Q2) of the total DC outputs.

Model A DC outputs are sourcing.

Model R DC outputs are sinking with integral pull up resistors. Model R also supports sourcing..

technical specifications continued...

1.8 Digital DC Inputs: Models R & A

Inputs per Module	12 Including 4 Configurable HSC Inputs	
Commons per Module	1	
Input Voltage Range	12VDC / 24VDC	
Absolute Max. Voltage	35VDC Max.	
Input Impedance	10kΩ	
Input Current:	Positive Logic	Negative Logic
Upper Threshold	0.8mA	-1.6mA
Lower Threshold	0.3mA	-2.1mA
Min ON Threshold	8VDC	
Max OFF Threshold	3VDC	
OFF to ON Response	0.1ms	
ON to OFF Response	0.1ms	
Number of Counters	4	
Maximum Frequency	500kHz	
Accumulator Size	32-bits each	
Modes Supported	Totalizer, quadrature, pulse measurement, frequency measurement, set-point controlled outputs	

1.9 Model R: Digital DC Outputs, Sinking, Sourcing

Outputs per Module	2 (PWM or HSC)	
Commons per Module	1	
Type	Sinking w/optional 10kΩ pull-up	
Absolute Max. Voltage	28VDC	
Output Protection	Short circuit	
Max. Output per Point: Sinking	0.5A	
Max. Output per Point: Sourcing	2.4mA @ 24V	
Max. Voltage Drop at Rated Current	0.25VDC	
Max Outrush	650mA	
	Min	Max
OFF to ON Time (typical)	2.2μs	2.2μs+ scan time
ON to OFF Time (typical)	13μs	13μs + scan time
PWM Out	65kHz	
Rise Time	2.4μs (typical @ 24V)	
Fall Time	7.5μs (typical @ 24V)	

1.10 Relay Outputs: Model R

Outputs per Module	6 Relay
Relay Contact Type	Floating
Max. Output Current per Relay	3A @ 60VAC, resistive 3A @ 30VDC, resistive
Max. Total Output Current	5A continuous
Max. Output Voltage	3A @ 60VAC, resistive 3A @ 30VDC, resistive
Max. Switched Power	150W
Contact Isolation to Ground	1000VAC
Max. Voltage Drop at Rated Current	0.5V
Expected Life (see derating chart on page 3)	No Load: 5,000,000 Rated Load: 100,000
Max. Switching Rate	300 CPM at no load 20 CPM at rated load
Type	Mechanical Contact
Response Time	One update per ladder scan plus 10 ms

1.11 Model A: Digital DC Outputs, Sourcing

Outputs per Module	12 Including 2 Configurable PWM Outputs	
Commons per Module	2	
Type	Sourcing	
Absolute Max. Voltage	28VDC	
Output Protection	Short Circuit, Thermal, Undervoltage	
Max. Voltage Drop at Rated Current	0.25VDC	
Max Output per Point: Sourcing	0.5A @ 24VDC	
	Min	Max
OFF to ON Time (typical)	300ns	500ns + scan time
ON to OFF Time (typical)	300ns	475ns + scan time
PWM Out	65kHz	
Rise Time	150ns Max	
Fall Time	150ns Max	

1.12 Analog Inputs: Models R & A

Number of Channels	4	
Input Ranges	0-20mA; 4-20mA; PT100 RTD	
RTD Temperature Range	-58° to 392°F (-50° to 200°C) PT100 DIN	
Nominal Resolution	12 Bits	
Safe Input Voltage Range	-0.5V to 12V, protection up to 24V	
Input Impedance (clamped @ -0.5VDC to 12VDC)	Current Mode: 100Ω	
Nominal Resolution	12 Bits	
%AI Full Scale	10V, 20mA, 100mV: 32,000 full scale RTD: 20 counts/°C	
Max. Over Current	25mA	
Max Error at 25°C (excluding Zero) Adjusting Filtering may Tighten	< 1.5%	
Filtering	160 Hz Hash (noise) Filter, 1-128 Scan Digital Running Average Filter	

1.13 Analog Outputs: Models R & A

Number of Channels	2
Output Ranges	0-20mA
Nominal Resolution	12 Bits
Update Rate	Once per PLC scan
Max. Error at 25°C (Excluding Zero)	< 1.5%
Maximum 20 mA Load	500Ω
% AQ Full Scale	32,000
Protection	Protect against miswire up to 24VDC auto-recover

X7 User Manual [MAN1155]

The User Manual includes extensive information on:

- Built-in I/O
- I/O Status and Calibration
- Common %S & %SR Registers
- HSC/PWM/Totalizer/Quadrature & Accumulator Registers
- Resource Limits

2 CONTROLLER OVERVIEW

3 WIRING: INPUTS AND OUTPUTS

2.1 - Port Connectors



1. Touch Screen
2. High Capacity microSD Slot
3. RS232/RS485 Serial Connector, CAN port (via RJ45), LAN Port (Ethernet)
4. USB Mini-B Port
5. Analog I/O, DC Inputs, DC Outputs
6. DC Power

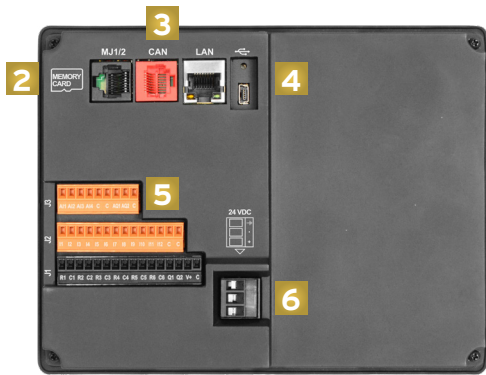

2.2 - Power Wiring

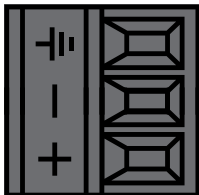

Primary Power Port Pins		
PIN	SIGNAL	DESCRIPTION
1	Ground	Frame Ground
2	DC-	Power Supply Common
3	DC+	Power Supply Voltage

DC Input / Frame

Solid/Stranded Wire: 12-24 awg (2.5-0.2mm).
 Strip Length: 0.28" (7mm).
 Torque Rating: 4.5 - 7 in-lbs (0.50 - 0.78 Nm).

DC- is internally connected to I/O V-.
 A Class 2 power supply must be used to meet UL requirements.

3.1 - Digital Inputs

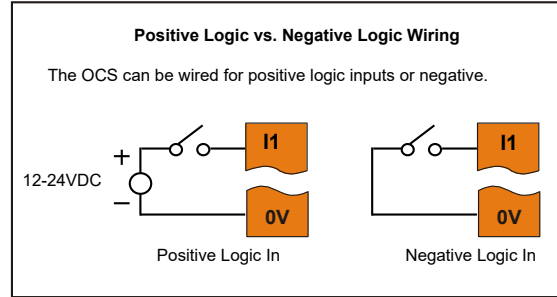

Digital inputs may be wired in either a Positive Logic or Negative Logic fashion as shown. The setting in the Cscape Hardware Configuration for the Digital Inputs must match the wiring used in order for the correct input states to be registered.

3.2 - Relay Life

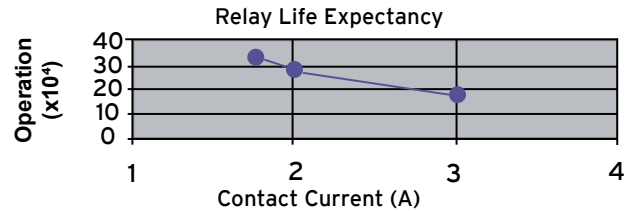

WARNING: Exposure to some chemicals may degrade the sealing properties of materials used in the Tyco relay PCJ.
Cover/Case & Base: Mitsubishi engineering Plastics Corp. 5010GN6-30 or 5010GN6-30 M8 (PBT)
Sealing Material: Kishimoto 4616-50K (1 part epoxy resin)
 It is recommended to periodically inspect the relay for any degradation of properties and replace if necessary.

Removing and Inserting Connectors:

Use a small screwdriver to gently pry up the connector. Gently press on connector to snap into place.

Wiring Details:

Solid/Stranded wire; 12-24 awg (2.5-0.2mm).
 Strip length - 0.28" (7mm)
 Torque rating: 4.5 - 7 in-lbs (0.50 - 0.78 Nm).

wiring: I-O continued...

3.3 - Analog Inputs Information

Raw input values are found in the registers as Integer-type data with a range from 0 - 32000.

Analog inputs may be filtered digitally with the Filter Constant found in the Cscape Hardware Configuration for Analog Inputs. Valid filter values are 0 - 7 and act according to the following chart.

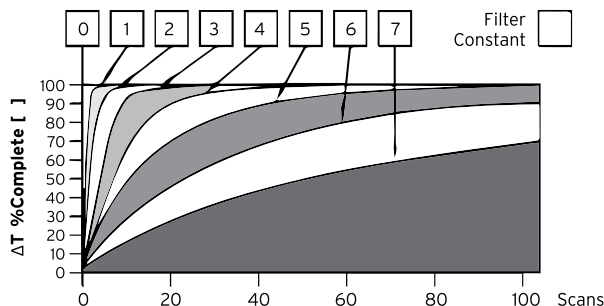

Data Values	
INPUT MODE:	DATA FORMAT, 12-bit INT:
0-20mA, 4-20mA	0-32000
RTD	20 Counts/ °C

J1 Wiring: Model R - Relay and Digital Out

POSITION/PIN	DIGITAL MODEL
1	R1 Relay 1 N.O.
2	C1 Relay 1 C
3	R2 Relay 2 N.O.
4	C2 Relay 2 C
5	R3 Relay 3 N.O.
6	C3 Relay 3 C
7	R4 Relay 4 N.O.
8	C4 Relay 4 C
9	R5 Relay 5 N.O.
10	C5 Relay 5 C
11	R6 Relay 6 N.O.
12	C6 Relay 6 C
13	Q1 Output 1
14	Q2 Output 2
15	V+ External V+
16	C Common

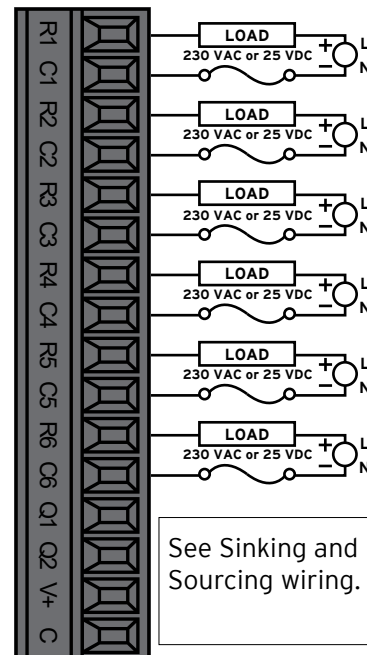

NOTE: Internal 10kΩ resistors between: V+ and Q1; V+ and C

3.4 - J1 Wiring

J1 Wiring Model A - Digital Out

POSITION/PIN	DIGITAL MODEL
1	Q1 Output 1 (PWM)
2	Q2 Output 2 (PWM)
3	Q3 Output 3
4	Q4 Output 4
5	V+ External V+
6	C Common
7	Q5 Output 5
8	Q6 Output 6
9	Q7 Output 7
10	Q8 Output 8
11	Q9 Output 9
12	Q10 Output 10
13	Q11 Output 11
14	Q12 Output 12
15	V+ External V 2 +
16	C Common

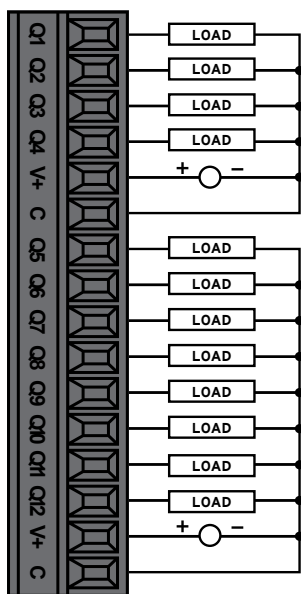

3.5 - Sourcing & Sinking Wiring on Model R

Model R: Sourcing Outputs

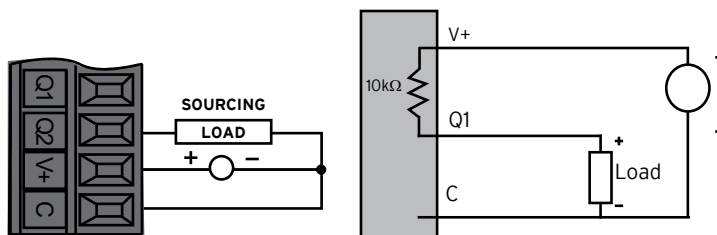

Sourcing: 2.4mA sourcing @ 24V

Model R: Sinking Outputs

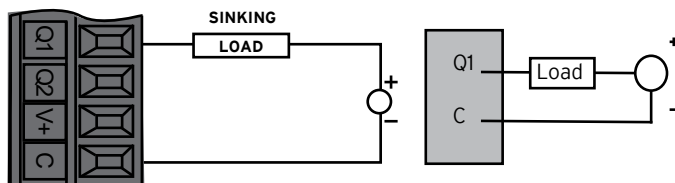

Sinking: Outputs can sink 500mA

wiring: I-O continued...

J2 Wiring: Model R & Model A - Digital Input

POSITION/PIN	DIGITAL MODEL	
1	I1	Input 1
2	I2	Input 2
3	I3	Input 3
4	I4	Input 4
5	I5	Input 5
6	I6	Input 6
7	I7	Input 7
8	I8	Input 8
9	I9	Input 9 (HSC1)
10	I10	Input 10 (HSC2)
11	I11	Input 11 (HSC3)
12	I12	Input 12 (HSC4)
13	C	Common
14	C	Common

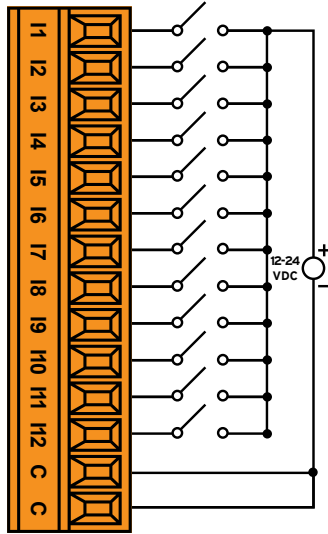

Removing and Inserting Connectors:

Use a small screwdriver to gently pry up the connector. Gently press on connector to snap into place.

Wiring Details:

Solid/Stranded wire; 12-24 awg (2.5-0.2mm).
Strip length - 0.28" (7mm)
Torque rating: 4.5 - 7 in-lbs (0.50 - 0.78 Nm).

4 x 4 - 20mA Input / 4-20mA Output

PIN	4-20mA I/O
1	AI1
2	RTD1+
3	AI2
4	RTD2+
5	AI3
6	RTD3+/AQ1
7	AI4
8	RTD4+/AQ2
9	Common

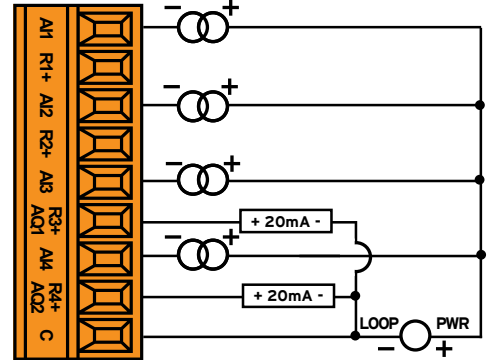

If AQ1 is used, RTD3 is unavailable.
If AQ2 is used, RTD4 is unavailable.

RTD: 4 x 2 - Wire RTD Connection

PIN	4 x 2 -Wire RTD
1	AI1
2	RTD1+
3	AI2
4	RTD2+
5	AI3
6	RTD3+/AQ1
7	AI4
8	RTD4+/AQ2
9	Common

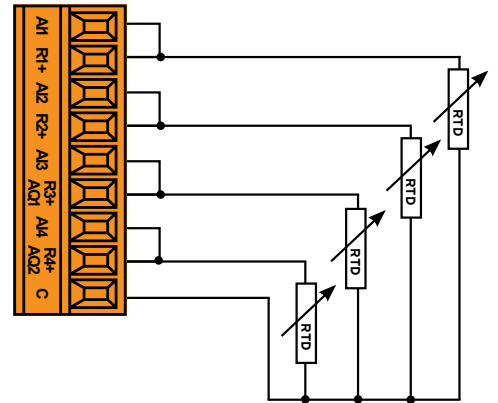

If AQ1 is used, RTD3 is unavailable.
If AQ2 is used, RTD4 is unavailable.

3.5 - J3 Wiring - Models A & R

RTD: 2 x 3 - Wire RTD & 2 x 4-20mA Output

PIN	2 x 3 -Wire RTD
1	AI1
2	RTD1+
3	AI2
4	RTD2+
5	AI3
6	RTD3+/AQ1
7	AI4
8	RTD4+/AQ2
9	Common

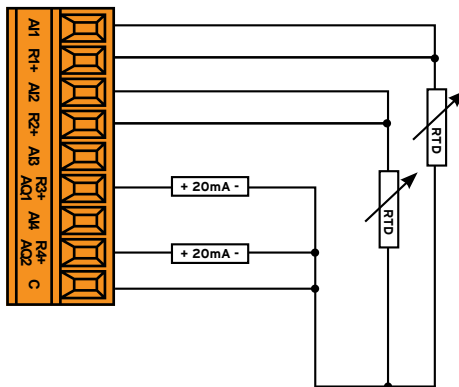

If AQ1 is used, RTD3 is unavailable.
If AQ2 is used, RTD4 is unavailable.

RTD: 4 x 3 - Wire RTD Connection

PIN	4 x 3 -Wire RTD
1	AI1
2	RTD1+
3	AI2
4	RTD2+
5	AI3
6	RTD3+/AQ1
7	AI4
8	RTD4+/AQ2
9	Common

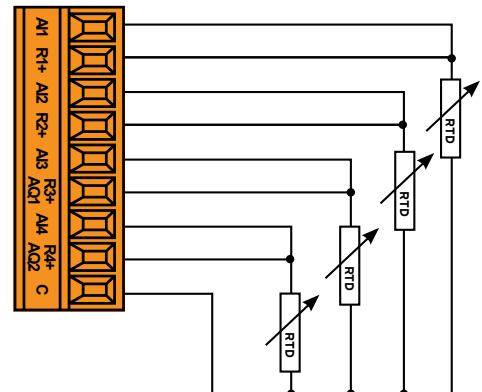

If AQ1 is used, RTD3 is unavailable.
If AQ2 is used, RTD4 is unavailable.

4 COMMUNICATIONS

4.1 - CAN Communications

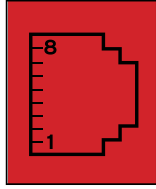

CAN

Modular jack (8 posn RJ45)

CAN Pin Assignments	
PIN	SIGNAL
8	No Connection
7	Ground
6	Shield
5	No Connection
4	No Connection
3	Ground
2	CAN Data Low
1	CAN Data High

The CAN port is provided via the single 8-position modular jack labeled "CAN". It may be used to communicate with other OCS products using Horner's CsCAN protocol. Additionally, remote expansion I/O such as SmartRail, SmartBlock, and SmartStix may be implemented using the CsCAN protocol.

Termination for the CAN port may be enabled from the System Menu or System Register. This should only occur if the X7 is at either end of the CAN network. Only the two devices on either end of the CAN network should be terminated.

4.2 - Serial Communications

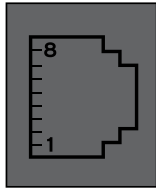

MJ1: RS-232 w/full handshaking

MJ2: RS-485 half-duplex

RS-485 termination and biasing via System Menu or System Register

MJ1 & MJ2 PINS		
PIN	SIGNAL	DIRECTION
8	TXD	OUT
7	RXD	IN
6	0V	Common
5	+5V @ 60mA	OUT
4	RTS	OUT
3	CTS	IN
2	RX-/TX-	IN/OUT
1	RX+/TX+	IN/OUT

4.3 - Ethernet Communications

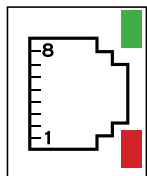

Link Indicator

Activity Indicator

10/100 Ethernet port with automatic MDI-X (crossover detection) is provided via the single 8-position modular jack labeled "LAN". Several features are available for use over Ethernet, such as WebMI, Modbus TCP/IP, Ethernet/IP, SMTP (E-mail), and more.

Ethernet configuration is done via the Cscape Hardware Configuration, though temporary Ethernet configuration may be done through the System Menu directly on the X7.

For more information on the Ethernet, available features and protocols, refer to the Ethernet Supplement document (SUP0740).

5 DIMENSIONS & INSTALLATION

5.1 Dimensions

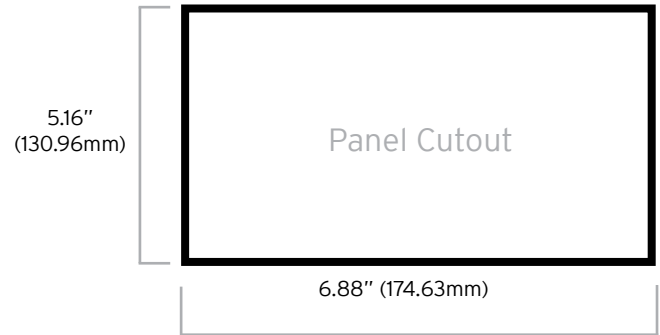
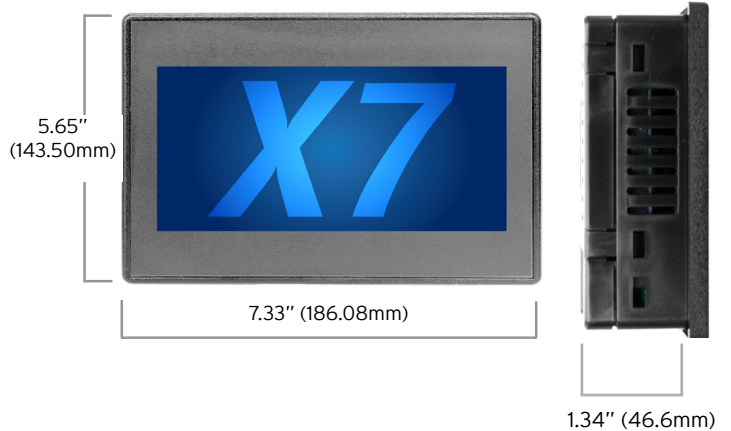

5.2 - Installation Procedure

The X7 utilizes a clip installation method to ensure a robust and watertight seal to the enclosure. Please follow the steps below for the proper installation and operation of the unit.

- Carefully locate an appropriate place to mount the X7. Be sure to leave enough room at the top of the unit for insertion and removal of the microSD™ card.
- Carefully cut the host panel per the diagram, creating a 130.96mm x 174.63mm +/-0.1mm opening into which the X7 is to be installed. If the opening is too large, water may leak into the enclosure, potentially damaging the unit. If the opening is too small, the OCS may not fit through the hole without damage.
- Remove any burrs/sharp edges and ensure the panel is not warped in the cutting process.
- Install and tighten the four mounting clips (provided in the box) until the gasket forms a tight seal. For standard composite mounting clips (included with product). **NOTE: Torque Rating is 2-3 in-lbs (0.23-0.34 Nm). For optional metal mounting clips, use a torque rating of 4-8 in-lbs (0.45-0.90 Nm).**
- Connect communications cables to the serial port, USB ports, and CAN port as required.

6 BUILT-IN I/O

6.1 - Built-in I/O (Model R & Model A)

Both X7 models feature built-in I/O. The I/O is mapped into OCS Register space, in three separate areas - Digital/Analog I/O, High-Speed Counter I/O, and High-speed Output I/O. Digital and analog I/O location is fixed starting at 1, but the high-speed counter and high-speed output references may be mapped to any open register location. For more details on using the high-speed counter and high-speed outputs, see the X7 OCS User's Manual (MAN1155).

FIXED ADDRESS	I/O FUNCTION	MODEL R	MODEL A
%I	Digital Inputs	1-12	1-12
	Reserved	13-32	13-32
%Q	Digital Outputs	1-2	1-12
	Relay Outputs	3-8	--
	Reserved	9-16	13-16
%AI	Analog Inputs	1-4	1-4
	Reserved	5-12	5-12
%AQ	Analog Outputs	1-2	1-2
	Reserved	3-6	3-6

7 SAFETY

7.1 - WARNINGS

- To avoid the risk of electric shock or burns, always connect the safety (or earth) ground before making any other connections.
- To reduce the risk of fire, electrical shock, or physical injury, it is strongly recommended to fuse the voltage measurement inputs. Be sure to locate fuses as close to the source as possible.
- Replace fuse with the same type and rating to provide protection against risk of fire and shock hazards.
- In the event of repeated failure, do NOT replace the fuse again as repeated failure indicates a defective condition that will NOT clear by replacing the fuse.
- Only qualified electrical personnel familiar with the construction and operation of this equipment and the hazards involved should install, adjust, operate, or service this equipment. Read and understand this manual and other applicable manuals in their entirety before proceeding. Failure to observe this precaution could result in severe bodily injury or loss of life.
- If the equipment is used in a manner not specified by Horner APG, the protection provided by the equipment may be impaired.

7.2 - FCC COMPLIANCE

This device complies with Part 15 of the FCC Rules. Operation is subject to the following two conditions:

- This device may not cause harmful interference
- This device must accept any interference received, including interference that may cause undesired operation

7.3 - PRECAUTIONS

All applicable codes and standards need to be followed in the installation of this product. Adhere to the following safety precautions whenever any type of connection is made to the module:

- Connect the safety (earth) ground on the power connector first before making any other connections.
- When connecting to the electric circuits or pulse-initiating equipment, open their related breakers.
- Do NOT make connection to live power lines.
- Make connections to the module first; then connect to the circuit to be monitored.
- Route power wires in a safe manner in accordance with good practice and local codes.
- Wear proper personal protective equipment including safety glasses and insulated gloves when making connections to power circuits.
- Ensure hands, shoes, and floor are dry before making any connection to a power line.
- Make sure the unit is turned OFF before making connection to terminals.
- Make sure all circuits are de-energized before making connections.
- Before each use, inspect all cables for breaks or cracks in the insulation. Replace immediately if defective.
- Use copper conductors in Field Wiring only, 60/75°C.

8 BATTERY

8.1 - Battery Maintenance

The X7 uses a replaceable non-rechargeable 3V lithium coin-cell battery (CR2450) to run the Real-Time Clock and to maintain the retained register values. This battery is designed to maintain the clock and memory for 7-10 years. Please reference MAN1155 for instructions on how to replace the battery.

9 PART NUMBER

9.1 - Part Number Builder

GLOBAL MODEL NUMBERS

model
HE-X7

R relay and solid state outputs
A solid state output

10 TECHNICAL SUPPORT

10.1 - Technical Support

For assistance and manual updates, contact Technical Support at the following locations:

North America
(317) 916-4274
www.hornerautomation.com
techspt@heapg.com

Europe
(+) 353-21-4321-266
www.horner-apg.com
technical.support@horner-apg.com